

# BRINGING NORTH SEA ENERGY ASHORE EFFICIENTLY



## ABOUT THE WORLD ENERGY COUNCIL

The World Energy Council is the principal impartial network of energy leaders and practitioners promoting an affordable, stable and environmentally sensitive energy system for the greatest benefit of all.

The following report is published by the World Energy Council The Netherlands ([www.wereldenergieraad.nl](http://www.wereldenergieraad.nl)) in collaboration with project partners

AkzoNobel, New Energy Coalition, Port of Amsterdam, Port of Rotterdam, PwC, Rabobank, Shell, Siemens Tennet, TNO, Vopak, Weero Koster (Energy Lawyer)

Formed in 1923, the Council is the UN-accredited global energy body, representing the entire energy spectrum, with over 3,000 member organisations in over 90 countries, drawn from governments, private and state corporations, academia, NGOs and energy stakeholders. We inform global, regional and national energy strategies by hosting high-level events including the World Energy Congress and publishing authoritative studies, and work through our extensive member network to facilitate the world's energy policy dialogue.

Further details at [www.worldenergy.org](http://www.worldenergy.org) and @WECouncil

## World Energy Perspective

World Energy Council Netherlands  
Data Copyright © 2017 World Energy Council Netherlands

All rights reserved. All or part of this publication may be used or reproduced as long as the following citation is included on each copy or transmission: 'Used by permission of World Energy Council Netherlands'.

Published by:  
World Energy Council Netherlands  
Registered in the Netherlands  
Nr. 62521780  
VAT n/a

Registered Office Stichting Energieraad Nederland  
Bredaseweg 406  
5037 LH Tilburg  
The Netherlands  
[bestuur@wereldenergieraad.nl](mailto:bestuur@wereldenergieraad.nl)  
Phone: +31(0)653106348



NEW ENERGY COALITION



SIEMENS



TNO



# TABLE OF CONTENTS

<b>1. Introduction</b>	
The North Sea in perspective	5
The future of North Sea energy production	5
Methodology and structure of the report	9
<b>2. Technology</b>	
The Electrons pathway	11
Connection and interconnection capacity to increase in the years to come	11
Electrification of end use	12
Battery technology	13
The Molecules Pathway	13
Conversion through electrolysis	14
Conversion offshore versus onshore	14
Storing hydrogen	17
Transportation of hydrogen	17
End uses	18
<b>3. Challenges and opportunities</b>	
Timing: the time to act now	21
The price of hydrogen: grey versus green	21
Role of ports as energy hubs	22
International cooperation	23
<b>4. The regulatory context</b>	
Coastal states' rights in the North Sea	25
EU regulation	26
Internal market access to the existing gas and electricity infrastructure	26
Unbundling	27
Deployment of alternative fuels infrastructure	28
Hydrogen and power-to-gas in the Clean Energy Package	28



<b>5. Case studies</b>	
Storing hydrogen in salt caverns (since 1972)	31
Statoil's experience in Carbon Capture Storage (since 1996)	32
Transport of hydrogen via onshore gas network in Zeeland (operational by 2018)	34
Hydrogen for the transport sector	36
Hydrogen Magnum power plant in Eemshaven (operational by 2023)	37
Hydrogen for heating - H21 Leeds City Gate (operational by 2032)	38
The North Sea Wind Power Hub (operational by 2035)	40
<b>6. The economics of North Sea energy pathways</b>	
The potential for a hybrid North Sea power and hydrogen future	47
From detailed information to a stylised economic model	48
<b>7. The call for action: public versus private sectors</b>	
Market failures and economic activity on the North Sea	52
Some potential hurdles to the optimal functioning of a green hydrogen market	53
Some potential hurdles to the optimal functioning of the offshore electricity market	54
<b>8. Conclusions &amp; recommendation</b>	
Important next steps for successful North Sea cooperation	57

# 1

## INTRODUCTION



## THE NORTH SEA IN PERSPECTIVE

Historically the North Sea has been an important source of economic growth for the countries surrounding it. Defence, transportation, fisheries, recreation, sand extraction and energy all have found their places on and around the North Sea. In the recent past oil and gas extraction has dominated economic activity on the North Sea.

Gas was first found in the Groningen area of the Netherlands in 1959, followed by the first UK discovery of gas in 1965, and of oil in 1969. In the following decades, discoveries grew in number, and by the mid-1980s there were over one hundred installations. By the early 1960s the Netherlands had become a net exporter of gas and in the 1980s the UK became a net exporter of oil (and by the mid-1990s also of gas). Over the following four decades, the North Sea energy industry developed into one of the world's most productive. At its peak in the late 1990s, production in Norway and the United Kingdom together accounted for almost 9% of global oil production.

As the North Sea emerged as an important oil producing area, it provided the backbone to the economic prosperity of the countries around it. To a large extent the availability of affordable feedstock helped develop the region's chemicals industry. Political stability and proximity to major European consumer markets made North Sea oil and gas attractive as more reliable alternatives to supply from, for example, the OPEC countries.

In the 1990s, like the rest of the world, the North Sea was affected by the fluctuation in world oil prices, but production still grew and peaked around the years 2000 and 2001. Now, the North Sea is regarded as a mature basin in a slow decline, but with substantial renewable energy sources to be explored, as outlined in this report.

## THE FUTURE OF NORTH SEA ENERGY PRODUCTION

Against the historical backdrop of the North Sea as the economic motor of North West Europe, it is important to once again start viewing the North Sea area as region which could supply a substantial share of Europe's energy and feedstock needs. With significant amounts of offshore wind energy coming online in the next decades, the North Sea has a clear opportunity to play a role in decarbonising both energy and feedstock supply in the years to come.

In the European Commission's reference scenario, a slight decline in final energy demand in the EU is foreseen to 2050, but the energy needs of industry, transport and heating for residential areas still continue to be significant. To reach the targets set out in the Paris climate agreement,<sup>1</sup> most of the energy needed to meet this demand will need to be carbon neutral, and likely renewable.

---

<sup>1</sup> The Paris Agreement sets out to reduce greenhouse gas emissions by 80 up to 95% in 2050 compared to 1990.

Offshore wind energy, is one of the fastest growing sources of renewable energy in the EU, together with on-shore wind and solar PV. Current plans mean that the North Sea countries could add between 180- 250 GW offshore wind capacity to 2050, from 10 GW today. The costs of electricity produced by offshore wind are rapidly declining, making it increasingly competitive compared to fossil fuel alternatives, as seen by several competitive bids in 2016 to construct offshore wind farms in Dutch and Danish waters (see WEC Netherland's 2016 report, The North Sea Opportunity).

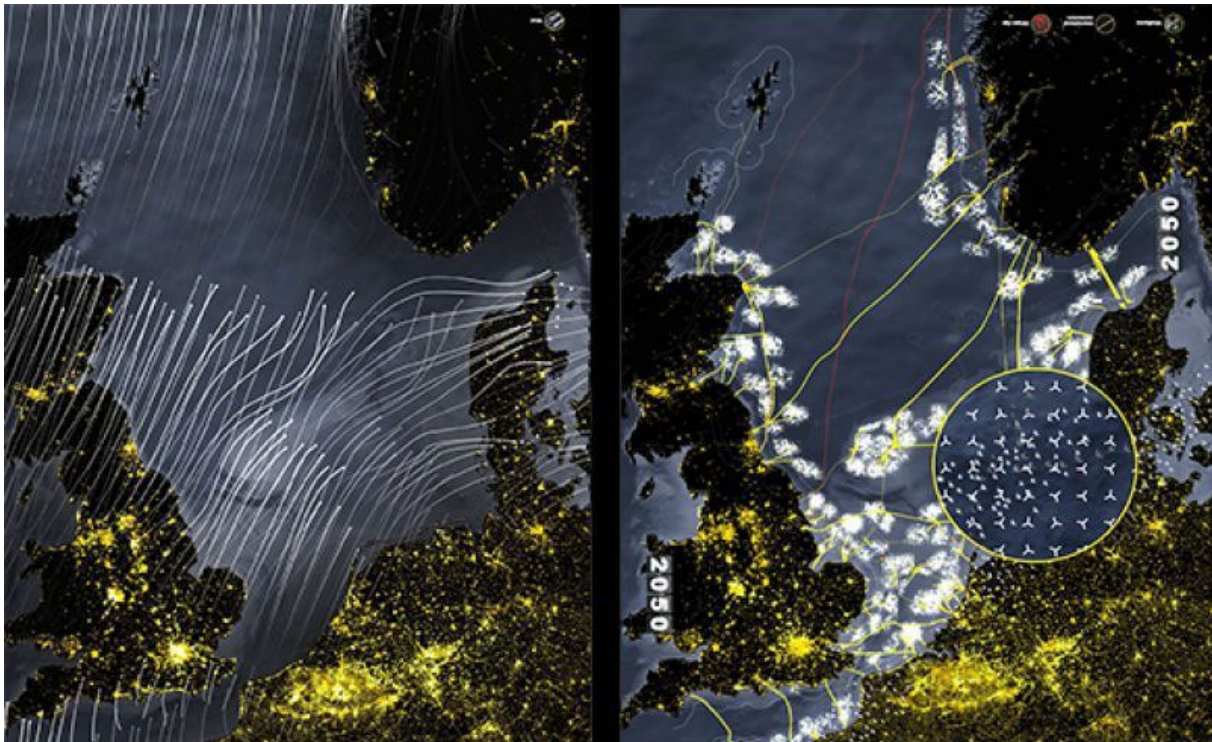

**Figure 1:** Impression of the North Sea now and in 2050. Source: IABR, Tungsten Pro

However, the success of offshore wind, and other renewables on the North Sea, depends on the ability to bring the energy to end consumers in an efficient way. Thus, parallel to the increased offshore implementation, ways to bring the energy to shore efficiently need to be developed.

This study will assess options for transport, conversion, storage and utilisation of the power generated, looking at two main pathways. Broadly speaking, power can either be transported to shore as electricity - we call this the electrons pathways - or, it can be converted (through electrolysis offshore or onshore) into hydrogen or related chemicals (ammonia, methanol or formic acid) and then transported to the end consumers - we call this the molecules pathway.



There can of course be many combinations of those pathways where conversion to hydrogen could happen onshore or offshore, and hydrogen could, in theory, be converted back into electricity once on shore. Our expectation for the future is that not just one pathway will dominate, but that there will be a combination of both. The objective is to find out what that combination should be.

In this study we focus on three main types of end users: residential areas/ buildings, transport and industry. In order to reduce CO<sub>2</sub> emissions, the heating of buildings could be either electrified or low temperature heat could be provided by replacing natural gas by hydrogen (see case study on Leeds City Gate project on p.19). For the mobility sector, renewable powered electric and hydrogen vehicles, are key options for decarbonisation.

In this context, industry remains the biggest challenge in the energy transition as both processes and feedstock are often highly carbon intensive. While electrification could help decarbonise processes, hydrogen from renewable energy sources may replace conventional (CO<sub>2</sub> intensive) hydrogen as feedstock.

For the purpose of this study it is important to stress that both pathways are CO<sub>2</sub> neutral and thus contribute to decarbonisation. The electrons pathway is the one currently used for operational and planned offshore wind farms, while the hydrogen pathway is considered to be a promising alternative on its own merits in respect of transport, storage and commercial application, but also because it may utilise the existing natural gas infrastructure and thus avoids decommissioning costs of such infrastructure.

For North West Europe there is a clear competitive advantage to acting early and explore the different options for bringing offshore energy ashore now. In addition to the substantial renewable resources in the form of offshore wind, the existing gas infrastructure provides a competitive advantage that stakeholders could capitalise on to be first movers, and lead technology development when it comes to green hydrogen.

Making use of local wind resources substantially increases security of supply, compared to imported options, such as green hydrogen from solar PV in places such as the Sahara, the Gulf area or Australia. Particularly for the molecules pathway, the North Sea countries could see substantial advantages from building a market for hydrogen at an early stage. As the rest of the world catches up, North West Europe could reap the benefits of being a first-mover.

However, developments are already ongoing in other parts of the world, such as the transportation of liquid hydrogen between Australia and Japan, or the production of hydrogen from solar PV in Oman. This means that the policy and technology choices to be made would need to be made now. Likewise, the choices need to be made on a solid fact basis to avoid lock-in effects and path-dependencies that may hinder development in the future.



CENTRAAL  
MAGAZIJN

DOKLOODSEN

RT BORKUM  
ROTTERDAM

RT BORKUM

36  
36  
34

Furthermore, it is worth noting, that offshore wind, and other renewables, does not only contribute to reducing CO<sub>2</sub> emissions, but also to a cleaner living environment for people. Initiatives such as the Clean Air Programme formulate clear objectives to be met by 2030 in terms of air quality. The programme sets national reduction commitments of atmospheric pollutants that have been found to have significant negative impacts on human health and the environment.<sup>2</sup>

### **METHODOLOGY AND STRUCTURE OF THE REPORT**

The report is based on information gathered from interviews with industry experts, as well as desk research. To complement this research we have also developed an economic model in order to calculate the costs and revenues of the possible pathways. According to the combinations of the two generic pathways mentioned above, six distinct paths to generate green hydrogen, incidental power, and power on demand have been defined. An overview of the combination of pathways and a description of the model can be found in chapter 5.

The next chapter elaborates on the technological aspects of the electrons and molecules pathways by touching on topics as production, transport, storage and end use of green energy. Challenges and opportunities in the development of a green electricity and green hydrogen market are discussed in chapter 3, while the North Sea regulatory context is drawn in chapter 4. Subsequently, seven case studies of projects related to the North Sea energy transition are presented. The results of the economic model based on high level scenarios and the years 2018, 2030 and 2050 are analysed in chapter 6, while chapter 7 describes actions to be taken by the public and private sector. The last chapter concludes and provides next steps for successful North Sea cooperation.

---

<sup>2</sup> European Commission press release (2016), EU approves new rules for Member States to drastically cut air pollution: [http://europa.eu/rapid/press-release\\_IP-16-4358\\_en.htm](http://europa.eu/rapid/press-release_IP-16-4358_en.htm)

# 2

# TECHNOLOGY



## THE ELECTRONS PATHWAY

The current offshore wind capacity on the North Sea stands at almost 10 GW with a confirmed pipeline of close to 60 GW in the years up until 2030. The UK has the largest offshore wind capacity in Europe at 5.4 GW while Germany takes the second place with close to 5 GW of installed capacity as well.

Currently most wind farms are located near shore and are connected by alternating current (AC) cables. In the future wind farms are expected to be built further out at sea. Wind farms that are located far from shore need to be connected to land via high voltage direct current (HVDC) cables, as the power losses on AC cables are significant on long distances (greater than 80km).<sup>3</sup> Because HVDC cables are relatively more expensive, connecting new wind farms by HVDC cables will require significant investments in connection capacity as wind farms move to far shore.

### CONNECTION AND INTERCONNECTION CAPACITY TO INCREASE IN THE YEARS TO COME

Confirming this view, there are significant investment plans going forward. According to current plans TenneT will have 17.1 GW offshore connection capacity in place in the German and Dutch parts of the North Sea by 2023. This represents an increase of 185% on current capacity.<sup>4,5</sup>

In this context, going forward, interconnection capacity, i.e. between more than one country, is also going to be crucial to the development of offshore energy on the North Sea. As larger amounts of variable energy enters the energy system, balancing becomes more important. Balancing would be enabled through the creation of a cross-border energy market.

For now there are only two operational interconnectors between North Sea countries - NorNed between Norway and the Netherlands (700 MW) and BritNed between the UK and the Netherlands (1,000 MW), but many more are planned in the coming five years.

**Table 1:** planned interconnections on the North Sea

Planned interconnections	Capacity (MW)	Planned year of construction/ operation
<b>COBRA:</b> Netherlands - Denmark HVDC	700	2019
<b>Nemo Link:</b> Belgium -UK	1,000	n/a
<b>NordLink:</b> Germany- Norway HVDC	1,400	2020
<b>North Sea Link:</b> Norway - UK HVDC	1,400	2021
<b>NorthConnect:</b> Norway - UK HVDC	1,400	2022
<b>Germany</b> - Denmark West (AC)	3,000	2022
<b>Viking Link:</b> Denmark - UK	1,400	2022

<sup>3</sup> The losses on HVDC cables on the other hand are less than 3%, including cable and converter losses.

<sup>4</sup> TenneT currently has a total of 6 GW of offshore connection capacity in place: TenneT (2016), Future North Sea Infrastructure.

<sup>5</sup> There are also offshore interconnectors that will be installed in addition to the planned offshore wind connection capacity of 17.1 GW.

So far interconnections have been linear between two countries, but the large capacity increase in energy from the North Sea means that linear solutions alone are likely to not be sufficient. Going forward solutions will include building international power hubs connecting multiple countries, such as the North Sea Wind Power Hub described in chapter 5.

## **ELECTRIFICATION OF END USE**

The importance of the power pathway is underlined by the current focus on electrification in the transition to a low carbon economy. Electrification of mobility, heating and industrial processes is already underway and will contribute to the ‘greening’ of those sectors. At this moment some technologies are becoming mature, and are being prepared for mass deployment. Electrification of transport enables the use of renewable electricity in vehicles through on-board batteries, but also through hydrogen fuel cells. More on this in the later part of this chapter.

Transport presents the most sizeable near-term electrification opportunity, driven by private passenger cars and short-range heavy duty vehicles. Moreover electricity is already used for trains, trams and buses. The number of electric passenger vehicles have been growing in number over the past years, but cost and charging infrastructure remain important barriers to overcome to make this development truly large scale.

An advantage of electrifying transport is that it would support the integration of variable renewable energy in the power generation mix, by contributing to balancing. Balancing could be done by timing battery charging of electric vehicles to coincide with surplus renewable electricity generation, and electric vehicles could also serve as two-way storage devices that could return electricity to the grid during periods of peak demand or act as a power storage for its owner.

In addition to electrification of transport, the electrification of low temperature heating in buildings is an important aspect of the transformation to a low carbon economy. Low carbon electricity could, in theory, replace fossil fuel use in buildings. In this context, residential heating is particularly important as it accounts for a significant proportion of the energy use in many countries. In the EU, 45% of energy for heating and cooling is used in the residential sector.<sup>6</sup>

Industry may be the most difficult sector to electrify, but it is a major consumer of fossil fuels, and thus its decarbonisation would substantially reduce CO<sub>2</sub> emissions. The sector is however very heterogeneous, and significant innovation would be required to develop electrified processes in many sectors. Nonetheless, some progress has already been made in energy intensive industries, such as the chemicals, and process manufacturing industries more generally, but also in steel production. Trends today suggest that a change in how industry uses electricity, as well as a change in their role in the electricity system, is possible as a part of a long-term transition towards a low carbon economy.

---

<sup>6</sup> European Commission (2016), An EU Strategy on Heating and Cooling.

## BATTERY TECHNOLOGY

Electrification will result in growing electricity demand, but also a growing demand for battery storage as an increasing share of generation will come from variable sources. Lithium-ion batteries are one of the key battery technologies, with deployment and cost reductions being driven by their use in consumer electronics and electric vehicles. Sodium-sulphur batteries are also currently being explored for commercial deployment. Recently there has also been developments in flow batteries where the energy is stored directly in the chemicals making up the electrolyte solution.

As the number of electric vehicles increase, batteries from old vehicles could be re-designed for use in stationary applications. End-of-life batteries from electric bicycles are already repackaged and sold as residential battery storage systems.

## THE MOLECULES PATHWAY

The molecules pathway involves the conversion of electrical power to gas by electrolysis, splitting water into hydrogen and oxygen.



Hydrogen could then be used as a fuel or combined with CO<sub>2</sub> and converted into methane or liquid fuels. This latter option provides an opportunity for using stored CO<sub>2</sub>, in a way recycling it and thus not letting it contribute to climate change. Furthermore, stored hydrogen could, technically speaking, also be converted back to electricity when needed, although this has a low range of round trip efficiency (30-50%). Nonetheless, its use is growing due to much higher storage capacity in comparison to other energy storage technologies (such as batteries).

To deal with the fluctuations in wind power supply from the North Sea, part of the energy produced could be converted to hydrogen through electrolysis and stored. This means that when wind power is not available, due to poor wind conditions or seasonal fluctuations, the stored hydrogen could be

### GREY, BLUE AND GREEN HYDROGEN

- So called, grey hydrogen is produced from natural gas through Steam Methane Reforming (SMR). This process is highly CO<sub>2</sub> intensive.
- Blue hydrogen is grey hydrogen, produced from natural gas, but where the CO<sub>2</sub> captured and either stored underground or used to create new compounds (CCUS).
- Green hydrogen is produced from wind, solar or other renewable power via electrolysis, separating water molecules into hydrogen and oxygen molecules.

There is a large and mature market for grey hydrogen. Large quantities of grey hydrogen are produced by the chemical industry and used as a feedstock. However, in order to reach the targets of the Paris Climate Agreement, markets for blue and green hydrogen would need to be further developed. This could be done by making use of existing grey hydrogen infrastructure.

converted back to electrical power via hydrogen fuelled gas turbines. In this way, large scale electrolysis could solve the problem of variable sources, and balances the electricity grid.

In addition, green hydrogen could also provide a solution to decarbonising processes that cannot be electrified. It could be used either as feedstock or burnt for high temperature heating with zero CO<sub>2</sub> emissions. In this way green hydrogen could play a role in decarbonising the chemicals industry, transportation and heating, as well as the production of electricity on demand.



**Figure 2:** Nel-Akzo Nobel alkaline water electrolysis



**Figure 3:** EnergiePark Mainz Siemens PEM water electrolysis

### CONVERSION THROUGH ELECTROLYSIS

Different electrolysis techniques exist, such as alkaline electrolysers and the newer PEM technology. Currently the costs of electrolysis are still high. However, the costs would decrease as production of green hydrogen increases, either by increased number of installed systems and increased capacity of systems (100 MW+). Additionally, the efficiency rate of converting wind power to hydrogen could increase with the scale-up of the electrolysis technology from 70 to 80%, resulting in saved costs.

### CONVERSION OFFSHORE VERSUS ONSHORE

The conversion of wind power to hydrogen could be done offshore or onshore. The advantage of offshore conversion is that the existing (retrofitted) natural gas infrastructure could be used to transport the energy to shore in gas form. This could save costs compared to developing an extensive offshore electricity grid - especially at distances further from land. Additionally, producing hydrogen offshore could help stabilise the offshore electricity grid closer to the variable source, and thus reducing the need for large cable infrastructures.

At sea there would be two options for hydrogen conversion in the long term. Hydrogen conversion could take place on retired oil and gas platforms close to wind farms, or in the longer run, on artificial islands that could act as energy hubs. However, there are space constraints on existing oil and gas platforms. Currently it is estimated that 250 MW electrolyser capacity could be fitted on a large



'mother' platform, while satellite platforms could host 60 MW electrolyser capacity. However, the capacity of wind farms are significantly larger, currently up to 630 MW in the North Sea, but with plans for 1.8 GW farms in the UK in the near to medium term future. That said, cables would always be needed to transport some of the energy to shore.

In the long term hydrogen conversion could also take place on artificial islands, connecting numerous wind farms to one power hub being the island. The most developed plan for construction such an island is the North Sea Wind Power Hub project which is expected to be ready to be operational by the early 2030s.<sup>7</sup> The advantage of hydrogen conversion on an artificial island is that the conversion takes place at the source of energy production, avoiding transport losses between wind farms and the conversion location. Even other basic chemicals like ammonia could be produced on the island itself. A disadvantage of offshore conversion is space constraints and potentially high transport costs to shore if existing pipelines are not available in the vicinity.

Yet, onshore conversion has the advantage that both the hydrogen and the oxygen produced could be captured more easily than offshore. Additionally, conversion onshore enables the production of other chemicals, such as methanol, without the need to transport these chemicals from sea to land. Ports could play a key role in onshore green hydrogen conversion. As an example, currently the equivalent of 2 GW of grey hydrogen is produced annually in the Port of Rotterdam from natural gas via CO<sub>2</sub> intensive SMR processes. In the future, hydrogen production is expected to (decarbonise and) increase to the equivalent of 12 GW.

Whether conversion should be done onshore or offshore depends on how far at sea the wind farm is located. When generating wind power close to shore (less than 80 km), using regular AC power cables to transport the electricity to shore then converting the electricity to hydrogen would be economically superior to offshore conversion. Worth bearing in mind, however, is that large scale onshore hydrogen conversion may lead to public resistance and safety issues, because hydrogen is highly explosive. The use of hydrogen by industry is however well established and should meet less resistance. The Port of Rotterdam for example already converts power to hydrogen onshore (hydrogen equivalent to 100 MW), under well-controlled and safe circumstances.

When generating wind power far at sea (>80 km) the use of HVDC conversion islands is the next step to bring electrical power onshore. Available wind park locations and superior wind conditions make the operation of such wind parks economically feasible.

For wind locations far from shore the costs of HVDC cabling is greater and offshore conversion would be economically superior to onshore conversion, since in this case you avoid high investments for HVDC cables and will also be able to balance the electrical grid of the wind park.

---

<sup>7</sup> A consortium currently consisting of TenneT TSO B.V. (NL), Gasunie, Energinet.dk, TenneT TSO GmbH (DE) and Port of Rotterdam.





**Figure 4:** The HelWin2 project includes the realisation of a 690 MW grid connection for wind farms near Helgoland



**Figure 5:** Interior view of a HVDC Plus converter station in Büttel in Schleswig-Holstein, the same technology as will be used for the COBRA converter stations.

## STORING HYDROGEN

A major advantage of converting electrical power to gas (hydrogen) is the ability to store it. Currently natural gas is widely stored in existing underground salt caverns. These salt caverns are also highly suitable for hydrogen storage, as salt is one of the best sealing rocks available in the subsurface, hence limiting explosion risks. Salt caverns have a minimum height of 300 metres, and can be up to 1500 metres deep. With those dimensions, one salt cavern alone would be able to store the equivalence of 3 TWh of hydrogen. Yet, an alternative is to store hydrogen in the form of ammonia or methanol. In the port of Rotterdam, for instance, there is a large methanol hub, which is able to store 2.5 kiloton methanol.

## TRANSPORTATION OF HYDROGEN

The well-developed on- and offshore gas pipeline infrastructure in Europe would be able to accommodate large volumes of electricity converted into gas. Transportation of hydrogen in existing modern pipelines under the right pressure conditions is being investigated but is most likely technically possible, both on land and offshore.

For the offshore gas grid, some pipelines will still be in use for natural gas in the coming years, but many will become idle as the natural gas resources in the North Sea decline. These idle gas pipelines could be used for the transportation of hydrogen to land. However, there are differences between the existing pipelines in the grid, and some are unsuitable for hydrogen transport, while others are suitable once they are retrofitted and yet others can be used without adaptation. However, when transporting hydrogen in most of the existing gas pipelines from offshore to onshore the loss is 10 to 20%, but when coating these gas pipelines the loss is reduced to 0.1%.

For transportation in existing pipelines hydrogen may also be mixed with natural gas and then separated from the methane on shore. Yet, another way of transporting hydrogen would be to convert the gas to liquid hydrogen, and then ship it to shore.

For onshore transportation, the North Sea countries have an extensive onshore gas network to transport its natural gas. As pipelines will be freed due to the decrease in natural gas production in Europe, they could be used transport hydrogen. In Zeeland in the Netherlands, Gasunie, the national gas grid operator, is currently working on a pilot project to test the suitability of an existing natural gas pipeline for the transportation of hydrogen, without retrofitting (see case study on hydrogen symbiosis on page 17).

In addition, there is an already existing network of pipelines for hydrogen transportation in North-West Europe owned by Air Liquide, which originates in Rotterdam and connects the Netherlands to Belgium, northern France and Germany (Ruhr area).

## END USES

The different end uses for green hydrogen would be electricity generation, feedstock for the chemicals industry, transportation and heating.

In the future, gas fired power plants could be transformed to power hydrogen plants, thus decarbonising the production of electricity on demand. An example would be the NUON Magnum plant project in the Eemshaven in the Netherlands (see case study on page 36).

In addition, there is a large market for hydrogen as feedstock to the chemicals industry. The demand for green hydrogen will increase as this industry needs to decarbonise and the price of renewable electricity is pushed down.

While out of the scope of this study, a pilot project in Sweden shows that also other industries have started to think about how to decarbonise their processes by using green hydrogen. In 2016 SSAB, LKAB and Vattenfall launched a joint project for the steel industry. The aim is to eliminate CO<sub>2</sub> emissions from steel making by using green hydrogen in the process of making steel from iron ore. The by-product of this type of iron ore reduction would be only water, compared to today's CO<sub>2</sub> intensive processes. Similarly, in Austria the so called H2 Future project aims to build one of the world's largest electrolysis demonstration plants for green hydrogen and make this hydrogen available for industrial use as well as for balancing the power reserve market. The project partners - Voestalpine, Siemens, VERBUND and Austrian Power Grid (APG) as well as the research-partners K1-MET and ECN - will build the demonstration plant at the Voestalpine site in Linz.

With regard to transport, battery electric transport is making large strides for passenger cars. However, hydrogen may also fulfil a substantial part of transport needs. In order for there to be a market for hydrogen cars, however, there is a need for fuelling stations to be built first. Some fuel retailers already started building hydrogen fuelling stations and various car manufacturers are developing hydrogen cars (see case study on page 36).

Likewise, to decarbonise road freight, options also include hydrogen fuelled heavy-duty vehicles. The technology is approaching commercialisation, but still faces some technical and economic barriers, including the scale and cost of associated distribution and fuelling infrastructure.

Finally, hydrogen may also be used for heating. The UK Leeds City Gate project is a pilot project aimed at transforming Leeds' natural gas network to hydrogen in order to decarbonise heating (see case study on page 38).

# 3

## CHALLENGES AND OPPORTUNITIES



## TIMING: THE TIME TO ACT NOW

As countries have committed to the goals of the Paris Climate Agreement, the choice today is no longer about whether to decarbonise our economies or not. The choices to be made is instead about how to do it. As outlined in the previous chapters of this report, the options are plentiful. If we also understand that lock-in effects of short term solutions and path-dependencies may hinder development in the future, the urgency to make the right choices now becomes even more apparent. These choices need to be made on a solid fact basis.

Choices made today, including decommissioning choices, are key to the further development of key technologies in both the molecules and the electrons pathway. Additionally, taking advantage of synergy effects that may arise from delaying decommissioning the economic gains could be substantial.

Replacing a fossil fuel based energy system by large scale offshore wind, leads to parts of the gas infrastructure in the North Sea to becoming idle. In this light, a decommissioning choice for wells, facilities and offshore pipelines<sup>8</sup> needs to be made. As previously described, some platforms and pipelines could be given a second life in the energy transition and be used for power conversion and transportation of green hydrogen. Some pipelines could also be used for CCS.

Before making the choice whether to decommission, it is important to look at this question from a broader perspective of the energy transition. Decommissioning choices will need to be made in the next decade and there is thus no time to loose in assessing the best available options. Globally other countries and regions are also moving ahead with the production of green hydrogen, adding an extra time pressure on Europe to act now.

## THE PRICE OF HYDROGEN: GREY VERSUS GREEN

The price of green hydrogen is not yet cost competitive, compared to grey hydrogen. Currently, the cost price of conventional hydrogen produced via Steam Methane Refining (SMR) is €1.5 per kilogram. In order for green hydrogen to be able to compete on a single hydrogen market, significant cost reductions would need to be achieved. In fact, it is estimated that green hydrogen prices would need to reach a level of €2.8 - €3.2 per kilogram in order be at par with grey hydrogen in a future scenario. (In the future, the cost price of grey hydrogen will increase as natural gas will become a scarce resource and the cost of CO<sub>2</sub> emissions is expected to increase.<sup>9</sup>

A few factors could help lower the price of green hydrogen, eventually making it competitive compared to conventional grey hydrogen. A large scale rollout of offshore wind would enable lower prices for green electricity, as an input to green hydrogen. Likewise, scaling up the production of green hydrogen from the renewable power available, would lower the green hydrogen price through economies of

---

8 For pipelines, decommissioning means cleaning and securing in place (potentially removing where necessary): EBN (2017), Netherlands masterplan for decommissioning and re-use

9 Jepma (2017), On the economics of offshore energy conversion: smart combinations

scale. Finally, learning effects in the development of new technologies would enable efficiency gains that would also lead to lower green hydrogen prices. Additionally, an improved EU ETS scheme which would reduce the number of CO<sub>2</sub> emission allowances – thus increasing prices – would discourage the production of grey hydrogen, and stimulate the production of green alternatives.

Similar to the case of green hydrogen, blue hydrogen is not yet cost competitive when compared to grey hydrogen. As the cost of blue hydrogen depends largely on the cost of CCS, important cost reductions in CCS technology would need to be achieved in order to make blue hydrogen competitive. Although blue hydrogen is not a renewable fuel, it is carbon neutral and could serve as a transition fuel in an intermediate phase during which the supply chains needed for hydrogen to replace fossil fuels are developed.

However, as with other products involving CCS, it is worth stressing its role as an intermediate fuel which would eventually need to be phased out by green hydrogen. In this context it is important to make choices that would not lead to blue hydrogen blocking the success of green hydrogen.

## **ROLE OF PORTS AS ENERGY HUBS**

North Sea ports could become important receivers of North Sea energy because of its natural location at the intersection of sea and land, and because ports have the industrial space and infrastructure needed for receiving stations, conversion plants, storage facilities and also possess networks for distribution of energy to inland end user, as ports are connected to the hinterland by extensive infrastructures, including road, rail, water, pipelines and cables. Moreover, ports often host large energy users in the port, such as chemical industries, refineries and steel industries. For those end users ports already provide warehousing, storage and logistics facilities, which could be adapted for a scenario whereby we see substantial hydrogen use in the future.

Ports are already becoming receiving points for power cables from offshore wind farms, and some ports have long been receiving points for natural gas from the North Sea. As the energy transition unfolds, adapting those ports to become receivers of renewable energy is paramount. In a low carbon energy system ports would need to act as storage facilities for energy, but also play a role in the large scale transportation of energy to other storage facilities.

Storage could take various forms from electrochemical storage in large batteries for balancing and short term storage to green molecules for longer term storage, including low temperature storage of liquid hydrogen (-253 °C). In terms of long term storage ports in North West Europe will also play a role in storage for the winter season, as well as for variations over the subsequent years, when for example some winters are colder than average. Against this background, there will be a need for conversion plants at the port location.



Both liquid fuels and electricity are suitable for storage at the ports' site, while gaseous carriers are more likely to be stored away from ports in dedicated underground storage facilities, such as salt caverns. For the transportation of gases, large scale compression and pumping capabilities would need to be present in the ports.

In addition, ports have substantial maritime know-how that could benefit all stakeholders as offshore wind is rolled out at an increasingly rapid pace and large amounts of wind turbines, long electricity cables, pipelines and platforms, as well as power hub islands need to be built. As an example of the latter, the Port of Rotterdam recently joined the consortium working on the North Sea Wind Power Hub on the Dogger Bank against its expertise in seaward land reclamation. Most ports are expected to build capabilities and capacity for type of this role in large scale projects that will mainly be carried out through public-private partnerships.

### INTERNATIONAL COOPERATION

Given the geography and the scale of the energy transition project, the North Sea countries would need to cooperate in order to achieve change. At the EU level there are already multiple examples of international cooperation around the North Sea, mostly initiatives at the sectoral level. Yet there is a need to put even further impetus behind this process.

Against this background, the declaration on energy cooperation between the North Seas countries signed by the governments of nine countries (Belgium, Denmark, France, Germany, Ireland, Luxembourg, the Netherlands, Norway, Sweden and subsequently the UK) in 2016, is an important milestone as it confirms the political commitment behind previous initiatives. One of the objectives of the declaration is to “reduce costs in the offshore wind sector, notably through exploiting the potential that regional cooperation offers in this respect, in particular with a view to reducing transaction costs and exploiting benefits of scale”.<sup>10</sup>

In this context, it is crucial that the momentum to further deepen international cooperation is used as North West Europe has an opportunity to make the North Sea a key contributor to a carbon neutral energy system. The EU could be a driving force that enables closer cooperation through pioneering cross border projects, such as the North Sea Wind Power Hub.

---

10 Political Declaration on energy cooperation between the North Seas Countries (2016)

# 4

## THE REGULATORY CONTEXT - NORTH SEA REGULATION ON THE TRANSMISSION OF ELECTRICITY AND GAS



## COASTAL STATES' RIGHTS IN THE NORTH SEA

The North Sea connects all six coastal states that are part of this study: Norway, Denmark, Germany, the UK, the Netherlands and Belgium, as well as Sweden and France. These coastal states have the right to exercise jurisdiction in the North Sea by the UN Convention on the Law of the Sea (UNCLOS). The convention divides the North Sea into several maritime zones. According to UNCLOS, the sovereignty of each coastal state extends to what is referred to as its “territorial sea”. This is the area from the coast line up to 12 nautical miles into the sea. A coastal state exercises full jurisdiction in its territorial sea, which means that all its national laws apply there automatically.

The UNCLOS furthermore allows coastal states to establish an “exclusive economic zone” (EEZ) – an area beyond the territorial sea, ranging up to 200 nautical miles off the coast. In such an EEZ, laws may apply if the coastal state decides so. However, UNCLOS limits the possibility for a coastal state to exercise jurisdiction in the EEZ to comprise only certain maritime activities, such as exploring, exploiting, conserving and managing natural resources, as well as to the construction and use of artificial islands, installations and structures, marine scientific research and the protection and preservation of the marine environment.

**Figure 6:** Map of the territorial sea and exclusive economic zones in the North Sea.



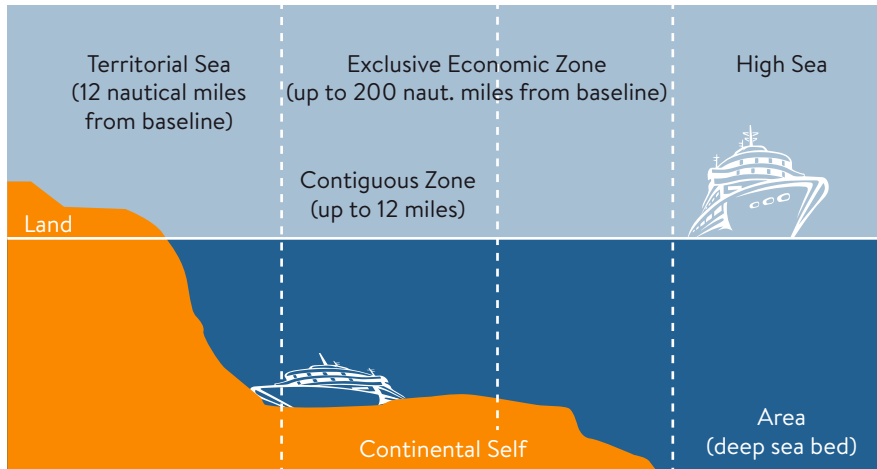

**Figure 7:** Cross section of the territorial sea and exclusive economic zones in the North Sea.

## EU REGULATION

Through the implementation of EU Regulations and Directives, energy policies developed at EU level influence energy policy in the individual member states. EU policy has significant impacts in areas such as market liberalisation, rate/ tariff regulation, the unbundling of grids and production facilities, and non-discriminatory third party access. The most important bodies of EU law in this area are the EU's 2009 Third Energy Package and the 2016 Clean Energy Package. EU regulation and policies do not apply to coastal states that are non-EU member states, such as Norway (and possibly the UK after Brexit). Separate national regimes in non-EU member states in the North Sea may therefore need to be taken into account in when engaging in cross border activities.

## INTERNAL MARKET ACCESS TO THE EXISTING GAS AND ELECTRICITY INFRASTRUCTURE

Bringing renewable power generated by offshore wind farms ashore, requires access to either the electricity grid (the electrons pathway) or the gas grid (the molecules pathway). The EU Electricity Directive<sup>11</sup> and the EU Gas Directive<sup>12</sup> each contain provisions on third party access rights (TPA), ensuring non-discriminatory access to transmission and distribution grids in EU countries. Under these Directives, operators of such grids have to provide either price regulated or negotiated access to their infrastructure.

Under certain circumstances, new infrastructure may be exempt from TPA rules, as becomes clear from the case studies of the BritNed cable and BBL pipeline.

11 The EU Electricity Directive (2009/72/EC).

12 The EU Gas Directive (2009/73/EC).

#### **TPA EXEMPTION ON NEW INFRASTRUCTURE GAS: THE BBL PIPELINE EXAMPLE**

The Balgzand-Bacton Line (BBL) is a natural gas interconnector between the Netherlands and the UK, exporting gas from the Netherlands to the UK. Its operator filed for exemption under the TPA rules in order to justify the €500 million investment in the BBL. The European Commission held that the exemption applies to:

- an initial 10 year period (which is the term of the initial contracts that BBL agreed with shippers who reserved capacity in the BBL); and
- the flow of natural gas from the Netherlands to the UK.

The European Commission takes the view that the project will enhance security of supply and competition in the UK. As this is not the case in the Netherlands, non-discriminatory access for reverse flow from the UK to the Netherlands can only be assured through TPA access.

In October 2016, the UK authority has extended the exemption for the operator of BBL for another two years in view of the fact that both countries have secure supplies of gas.

#### **TPA EXEMPTION ON NEW INFRASTRUCTURE ELECTRICITY: THE BRITNED EXAMPLE**

BritNed is a high-voltage direct-current submarine power cable between the UK and the Netherlands. It is a joint venture between the British and Dutch TSOs.

The main reason for the exemption request from BritNed is that, based on the TPA rules, the regulator would be able to cap or entirely remove returns to the investors if the interconnector were to become commercially successful. At the same time, the regulator would be able to demand that the operator expands capacity while preventing socialisation of costs if the project proves to be unsuccessful.

The exemption was granted, but the European Commission requested the national authorities to add a condition to the exemption to the effect that BritNed was to submit a report to the UK and Dutch authorities within 10 years after the start of operation, which would provide details allowing the costs, revenues and rates of return of the project to be scrutinised.

## **UNBUNDLING**

The EU Electricity and Gas Directives also mandate a structural separation between transmission system operator (TSO) activities on the one hand and activities related to generation, trade and supply on the other (commonly referred to as “unbundling”). TSO activities include onshore and offshore electricity transmission, electricity interconnection, gas transmission and gas interconnection. The aim of these rules is to increase competition in the EU energy market and to prevent possible abuse of market power, by ensuring the independence of electricity and gas transmission services from generation, production and supply.

EU member states have three options for implementing the unbundling rules into their national laws: (i) full ownership unbundling, (ii) appointment of an independent system operator (ISO) and (iii) appointment of an independent transmission operator (ITO). The first option is preferred by the regulator, as it prevents TSOs from forming a part of a vertically integrated group. The second and third option each allow some degree of vertical integration. The countries in scope of this study all have appointed TSOs.

The directives also regulate distribution system operators (DSO), but the unbundling regime for DSOs is less stringent than that for TSOs.

## DEPLOYMENT OF ALTERNATIVE FUELS INFRASTRUCTURE

In order to gradually reduce the dependency on oil in the mobility and transport sector, the EU has set a target of a market share of 10% of renewables in transport fuels by 2020 in its Renewable Energy Directive. In order to meet this target, the EU has identified the main alternative fuels for long-term substitution of oil. These alternatives include hydrogen.

The EU has established a common framework for the deployment of alternative fuels infrastructure in the Alternative Fuels Infrastructure Directive. This Directive sets minimum requirements for building up an alternative fuels infrastructure, including recharging points for electric vehicles and refuelling points for natural gas and hydrogen vehicles. Member states that decide to include hydrogen refuelling points in their national policy frameworks, have the obligation to ensure that, by December 2025, an appropriate number of refuelling points will be available.

## HYDROGEN AND POWER-TO-GAS IN THE CLEAN ENERGY PACKAGE

No harmonised rules specifically related to hydrogen and power-to-gas technology currently exist in the EU. Different laws apply in individual member states resulting in different approaches to encourage investment in the hydrogen and power-to-gas industry. The EU does, however, acknowledge hydrogen as an important way to improve the security of supply and to reduce CO<sub>2</sub> emissions and identifies hydrogen from solar and wind as a carbon free universal energy carrier that could serve as a transport fuel and which enables energy storage. The Clean Energy Package includes the following initiatives towards a harmonised approach to power-to-gas technology.

**Definition of energy storage:** in the current EU regulatory framework energy storage is not explicitly regulated. The Gas Directive includes detailed provisions for gas storage and refers to storage as one core element of the gas distribution system. In contrast to the Gas Directive, the Electricity Directive was not designed with energy storage in mind. In the Clean Energy Package special attention is given to the power-to-gas energy storage and green hydrogen. The European Commission introduced a new

---

13 Energy storage is defined as “the act of deferring an amount of the energy that was generated to the moment of use, either as final energy or converted into another energy carrier.”

definition for electricity storage in the electricity system.<sup>13</sup> This definition includes the conversion of electricity into another carrier, which allows for power-to-gas applications. Under the new definition, power-to-gas plants and hydrogen refuelling stations would be able to offer storage facilities to the electricity market, while selling hydrogen to the mobility and gas sectors.

**Tackling double costs:** the European Commission relies on the principle that, in order to avoid double pricing and taxation, a generator or consumer that integrates a storage facility at its location should not be discriminated in the energy system, neither in terms of obligations nor in terms of eventual support that it receives in the energy system.

**Coupling of generation, storage and demand response:** the revised Electricity Directive in the Clean Energy Package recognises a key role for demand side and load management. Power-to-gas technology will need to be able to be instructed by grid operators to provide up or down responses for grid services (including frequency balancing services payment across the EU). The European Commission proposes that market operators provide products for day-ahead trading and intra-day markets with minimum bid sizes of 1 MW or less. This is designed to encourage the participation of demand side response, energy storage and small scale renewables.

**Guarantee of origin scheme for hydrogen:** in the revised Renewable Energy Directive, the scope of the Guarantees of Origin scheme for renewable energy is extended to gaseous renewable fuels, including hydrogen. A carbon intensity threshold for hydrogen will be applied and certificates awarded to producers of low-carbon hydrogen.



# 5

## CASE STUDIES





## STORING HYDROGEN IN SALT CAVERNS (SINCE 1972)

Salt caverns have successfully been used for underground storage of natural gas dating as far back as 1972. In Germany about 170 caverns are currently used for the storage of natural gas for seasonal load balancing, shut-down reserve, and as trading reserves. Moving towards a green energy system, storing green hydrogen would be a good solution for balancing energy supply and demand - for periods of poor wind or seasonal fluctuations.

Salt caverns are very suitable for storing hydrogen, because salt is one of the best sealing rocks available in the subsurface, thus preventing any leakages. Salt caverns have a minimum height of 300 metres and can be 1500 metres deep. One average salt cavern would be able to store the equivalent of 3 TWh of hydrogen. Storage of hydrogen in underground salt caverns is also much safer than storage at the surface. The walls of salt caverns are typically 10 to 100 metres thick, and salt caverns can nearly never explode because the gas pressure is always below the encompassing pressure.<sup>14</sup>

One German case study on storage of hydrogen in salt caverns found that if the German power surplus (7% of total variable renewable generation by 2025 and 20% by 2050) would be converted to hydrogen and stored underground, these quantities would require some 15 caverns of 500,000 cubic metres each by 2025 and some 60 caverns by 2050 – corresponding to approximately one third of the number of underground gas caverns currently operated in Germany.

**Figure 8:**  
Salt cavern

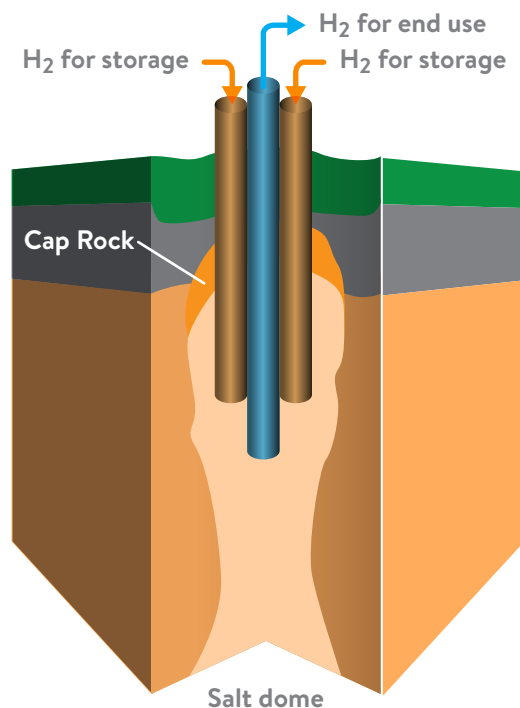

<sup>14</sup> Gasunie (2017), Waterstofopslag HyStock van aardgasbuffer naar energiehub.

Nonetheless, in order to provide storage space for all the North Sea countries new hydrogen caverns may need to be explored. The most favourable geological conditions for gas storage caverns exist in north-west Germany and north-east Netherlands, but the UK also has suitable salt caverns for hydrogen storage.

Currently there are four hydrogen salt caverns in operation globally, three in the USA and one in the UK. Table 2 provides information about their location and volume. All current hydrogen cavern projects are used by the chemical industry, which has high quality standards for the purity of hydrogen gas. Based on these current hydrogen storage facilities, the storage of pure hydrogen in caverns is technically feasible. Future hydrogen cavern projects could make use of previous experience in the USA and the UK.

**Table 2:** Existing hydrogen caverns

	Teesside (UK)	Clemens Dome (USA)	Moss Bluff (USA)	Spidletop (USA)
Geology	Bedded salt	Salt dome	Salt dome	Salt dome
Operator	Sabic Petrochemicals	ConocoPhillips	Praxair	Air Liquide
Year	1972	1983	2007	n/a
Volume (m3)	3*70,000	580,000	566,000	906,000
Mean cavern depth (m)	365	1,000	1,200	1,340
Pressure range	45	70-137	55-152	68-202
H2 capacity (GWh)	27	81	123	274
Amount of H2 (tonnes)	810	2,400	3,690	8,230

Source: Letcher (2016), Storing Energy – with Special Reference to Renewable Energy Sources

### STATOIL’S EXPERIENCE IN CARBON CAPTURE STORAGE (SINCE 1996)

Norwegian Statoil has long-standing experience in Carbon Capture and Storage (CCS) and has been running successful CCS projects for over 20 years. Incentivised by high tax rates on CO<sub>2</sub> emissions Statoil has been running both offshore and onshore CCS projects in Norway and in Algeria. In total, Statoil has permanently stored over 23 Mt of CO<sub>2</sub> underground.<sup>15</sup>

With CCS technology CO<sub>2</sub> is captured from fuel combustion or industrial processes, and is then transported using ships, trucks or pipelines to be stored underground for long time periods (see figure 9). An economic advantage of CCS is the possibility to extend the current extraction of fossil fuels, while cancelling CO<sub>2</sub> emissions.

15 Statoil (2017), Statoil evaluating new CO<sub>2</sub> storage project on the Norwegian continental shelf.

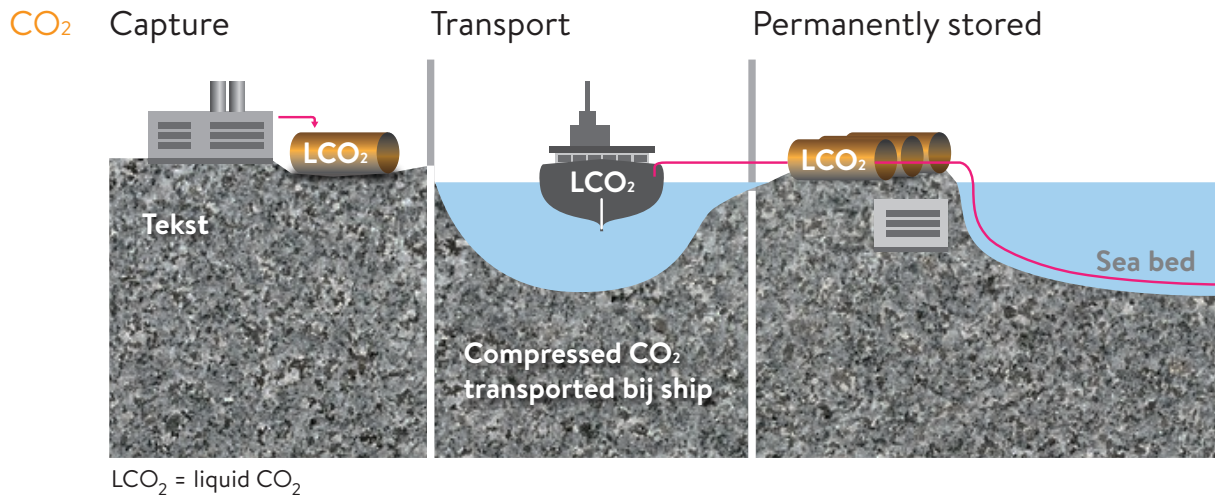
**Figure 9:** Carbon Capture Storage process

However, the costs of CCS are currently very high, primarily due to the 25% additional power that is needed for power plants to capture and compress carbon, but also due to the need for more facility space. Nevertheless, CCS will likely be a necessary technology in order to meet the 2 degree target that countries committed to in the Paris Climate Agreement. The challenge for the industry is to make CCS a positive business case. This could be achieved by increasing the size and scale of CCS projects worldwide, or if CO<sub>2</sub> emission prices would increase.

This year Statoil signed a new project together with the Norwegian subsidiaries of Shell and Total for storing CO<sub>2</sub> captured at industrial facilities in eastern Norway at an offshore site. The project has the potential to be the first storage project site in the world receiving CO<sub>2</sub> from industrial sources in multiple countries and could therefore be a good example for other international CCS projects.

**Table 3:** Statoil's CCS projects since the mid-1990s

<p><b>Sleipner, Norway since 1996</b></p> <p>1.0 Mt of CO<sub>2</sub> per year is captured from the natural gas Sleipner field and stored in the form of a liquid 1 km below the seabed in the Norwegian sector of the North Sea.</p>	<p><b>In Salah, Algeria since 2004</b></p> <p>Statoil has helped capture and store more than 3 Mt of CO<sub>2</sub> in a producing onshore gas reservoir.</p>
<p><b>Snohvit, Norway since 2008</b></p> <p>The Snohvit field supplies gas to a LNG plant with CO<sub>2</sub> capture and storage in the Barents Sea. In total 1.0 Mt of CO<sub>2</sub> has been stored.</p>	<p><b>Statoil co-owner of Technology Center Mongstad, Norway since 2012</b></p> <p>2 units are used by vendors to test and improve CO<sub>2</sub> capture technology. In total 100.000 tonnes of CO<sub>2</sub> is captured per year.</p>

Source: Statoil website, New Energy Solutions (<https://www.statoil.com/en/what-we-do/new-energy-solutions.html>)

Finally, it is not only possible to capture and store CO<sub>2</sub>, but CO<sub>2</sub> may also be captured and used, thus delaying its release into the atmosphere.<sup>16</sup> For example, green hydrogen can be used to produce other sustainable energy carriers and feedstock such as ammonia, methanol and synthetic fuels. In the process of producing these chemicals carbon is often required. At the present time this is often provided by syngas, but could be replaced by residual streams of CO<sub>2</sub> from industries such as steel, through Carbon Capture and Utilisation (CCU) technology. As carbon becomes an increasingly scarce resource in a low carbon energy system, CCU will likely become a preferred option to CCS.

### TRANSPORT OF HYDROGEN VIA ONSHORE GAS NETWORK IN ZEELAND (OPERATIONAL BY 2018)

The Hydrogen Symbiosis is a pilot project in the Dutch region of Zeeland in which the companies Dow Benelux, Yara and ICL IP are planning to exchange hydrogen for industrial applications via the natural gas transport network of Gasunie, the national gas grid operator.<sup>17</sup> The project is the first industry collaboration between energy intensive industries in the Dutch-Belgium Delta region.<sup>18</sup>

At Dow's site in Terneuzen, hydrogen is released as a by-product of Dow's cracking processes, and is currently used as a fuel for Dow's own production of plastics. Yara and ICL-IP, instead, use hydrogen as a raw material for its production of fertilisers. Currently Yara produces its own hydrogen from natural gas, and ICL-IP receives hydrogen from supply by road.

The purpose of the project is to transport the hydrogen released at Dow via an idle Gasunie gas pipeline to Yara and ICL-IP. The benefit for Yara will be significant as it can decrease its own hydrogen production. The benefit for ICL-IP will be an 80% decrease in the need for hydrogen from other sources supplied by road transport, and hence a reduction in the associated CO<sub>2</sub> emissions.

The objective is to exchange 4,500 ton of hydrogen per year. This would lead to a significant decrease in energy consumption - equal to the gas consumption of nearly 3,000 households. The reduced energy consumption together with the decreased production of 'conventional' hydrogen at the Yara site, would also reduce CO<sub>2</sub> emissions at the scale of 20,000 to 40,000 - or equal to the annual heat demand of 10,000 to 20,000 people.<sup>19</sup>

---

16 European Commission, Smart Specialisation Platform: <http://s3platform.jrc.ec.europa.eu/carbon-capture-and-utilization>.

17 The project, is realised through the so-called Green Deal and was signed in March 2016 by the Dutch government and the parties involved: Dow Benelux BV, Yara Sluiskil BV, ICL-IP Terneuzen BV, Gasunie Transport Services, Provincie Zeeland, NV Economische Impuls Zeeland, and Zeeland Seaports.

18 The Dutch-Belgium Delta region includes West North Brabant, Zeeland and the Flemish part of the Gent-Terneuzen Canal Zone.

19 Gasunie (2016), Green Deal: hydrogen transport via Gasunie gas network makes industry in Zeeuws-Vlaanderen stronger and more sustainable.

**Figure 10:** Hydrogen transport via gas pipeline from DOW to Yara and ICL.

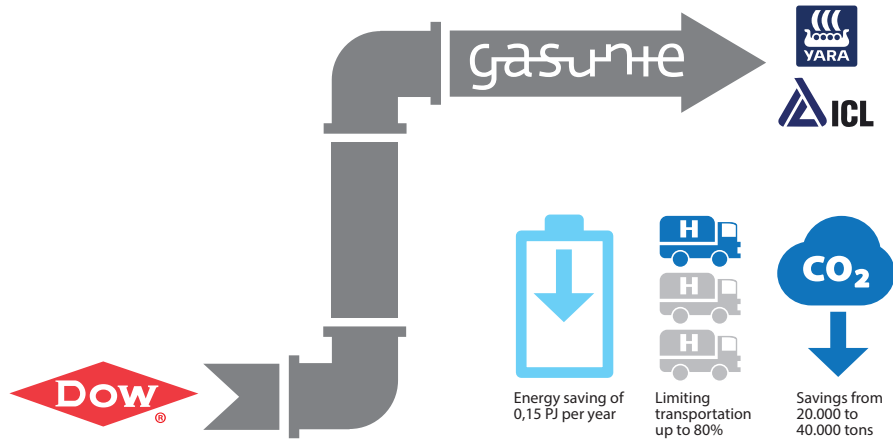

The business case has potential to be scaled up to include other companies in and beyond the Delta region. This would both strengthen the international competitiveness of the companies and reduce CO<sub>2</sub> emissions significantly. It would also provide a sustainable, efficient and safe method to transport hydrogen, and contributes to developing an industry in which the dependency on fossil energy and scarce raw materials is reduced.

The project was initiated in order to show that hydrogen can be transported using existing natural gas infrastructure. By signing off on this pilot project the Dutch government shows that it is ready to revise the current regulatory framework in order to enable the use of hydrogen in industrial processes in order to promote green growth. The province of Zeeland has reserved a maximum grant of € 200,000 for research on how to scale up the project.

## HYDROGEN FOR THE TRANSPORT SECTOR

Hydrogen can be used in fuel cells to generate electricity on which vehicles can drive, emitting only water vapour in the process.

### HOW IT WORKS

1. Hydrogen tanked at a hydrogen fuel station is stored in the vehicle's tank and supplied to the fuel cell stack.
2. Inflow of air is supplied to the fuel cell stack.
3. The reaction of air and hydrogen in the fuel cell stack generates electricity and water.
4. The electricity generated is supplied to the vehicle's motor and battery.
5. During the process only water comes out.

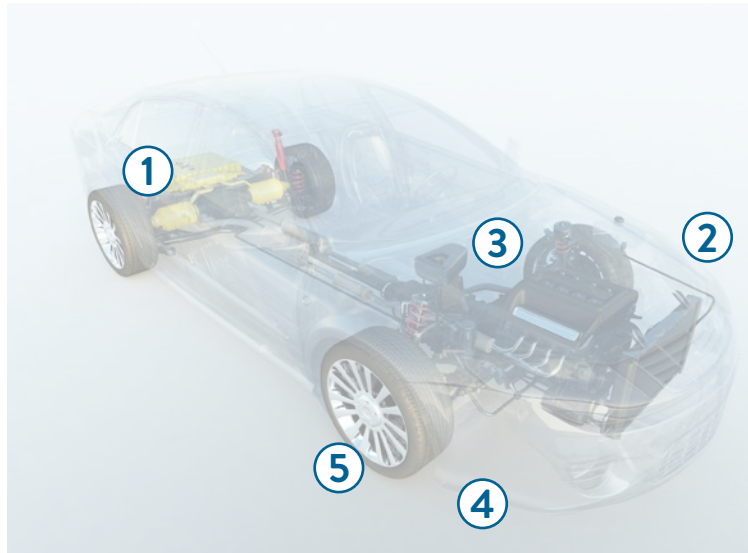

**Figure 11:** A hydrogen vehicle and how it works

Car manufacturers Hyundai, Toyota and Honda have developed hydrogen cars since 2016, and those are now available to the public. In addition, TU Delft is currently working on the project Car as Power Plant, in which they research the possibilities for fuel cells in a car to produce green electricity from hydrogen, also when the car is not driving as a means to supply electricity to homes and offices.

However, car manufacturers are still restrained in large scale production of hydrogen cars as there are not yet enough hydrogen fuel stations, which in turn delays the development of a 'hydrogen for transport' market. The European Commission recognises this issue and will therefore invest € 162 million over a period of five years – making this the largest hydrogen-fuel project of its kind in Europe.

The HyFIVE<sup>20</sup> project aims to promote the development of hydrogen cars and encourage manufacturers to cooperate with fuel suppliers and government bodies to support this technology.<sup>21</sup> By 2022, 55 refuelling stations are planned to be built and 1,735 hydrogen cars, vans and trucks are planned to be deployed in London, Swindon, Copenhagen, Stuttgart, Munich, Innsbruck, Aarhus, Korsor, Malmo and Bolzano. This is a 175% increase in fuel stations compared to today and may provide the foundations of a carbon neutral refuelling network.

20 Partners of the project are: Greater London Authority, European Commission, the Danish Partnership for Hydrogen and Fuel Cells, Thinkstep, BMW, Daimler, Honda, Hyundai, Toyota, and the power companies, H2 Logic, Shell, Total, Air Liquide, Hydrogen Link, Hydrogen Sweden, HyNor, HyOP, AGA, Icelandic New Energy, AREVA, McPhy, Air Products, BOC, Danish Hydrogen Fuel, ITM Power, Linde, OMV, Element Energy and IIT.

21 Apolitical (2017), Europe puts thousands of hydrogen cars on the road.

To increase the number of fuel stations other initiatives are also in place:

- In Germany the H2 Mobility<sup>22</sup> initiative wants to raise the number of hydrogen fuelling stations to 400 stations in 2023 (from 100 stations in 2017) at a cost of €350 million.
- In Norway, Uno-X in partnership with NEL ASA plans to build 20 hydrogen fuelling stations before 2020.
- In Denmark, H2 Logic is building a factory in the city of Herning to manufacture 300 hydrogen fuelling stations per year, each capable of providing 200 kilograms of hydrogen per day.
- In the Netherlands the public-private platform H2NL aims putting at approximately 2000 light and heavy duty fuel cell hydrogen vehicles, including buses and 20 stations, on the roads by 2020.<sup>23</sup>

The environmental advantages of hydrogen fuel cell technology over conventional fossil fuel engines are significant as hydrogen cars are completely NO<sub>x</sub> and CO<sub>2</sub> emission free. So, if transport would run on hydrogen major CO<sub>2</sub> reductions could be achieved and supports the local air quality in cities. Finally, costs are still high, but are expected to decrease as the hydrogen technology and its market further develops.

### **HYDROGEN MAGNUM POWER PLANT IN EEMSHAVEN (OPERATIONAL BY 2023)**

The Magnum project in Eemshaven outside of Groningen in the Netherlands aims to use hydrogen as a fuel instead of natural gas in one of the three units of Nuon's Magnum power plant.<sup>24</sup> The project is a collaboration between Nuon/ Vattenfall, Dutch Gasunie and Norwegian Statoil. The Magnum power plant was designed to be able to use multiple types of fuels. As such, the technical part of the project is rather simple, and the added advantage of the project would be in creating a supply chain for hydrogen.

Natural gas power plants play an important role in ensuring the reliability of the power supply in the Dutch energy system. Safeguarding this stability will become increasingly important as the portion of solar and wind energy increases. As natural gas would be phased out, hydrogen could play an important role for this balancing.

To begin with the plant will be supplied with blue hydrogen produced by Statoil, while later stages of the project envisages green ammonia (derived from green hydrogen from wind and/ or solar power) after 2030. Until green ammonia replaces blue hydrogen, the CO<sub>2</sub> resulting from the hydrogen production process will be stored through CCS near the Norwegian shore. At the moment Gasunie is looking into the options of either transporting hydrogen from Norway to Eemshaven via gas pipelines or by shipping liquid hydrogen.

---

22 Partners of the H2 Mobility initiative are Air Liquide, Daimler, Linde, OMV, Shell and Total.

23 ECN (2015), Advances in hydrogen activities in the Netherlands.

24 Nuon (2017), Nuon, Statoil en Gasunie werken samen aan de inzet van waterstof in een CO<sub>2</sub> -vrije energiecentrale.

The potential direct CO<sub>2</sub> emission reduction from replacing natural gas by hydrogen in the Magnum plant is estimated at 4 million tonnes of CO<sub>2</sub> per year – or the equivalent of the emissions of 500,000 households. With the knowledge and experience gained in this project, other gas powered power plants could also be adapted into becoming hydrogen power plants in the future – making this project one example of CO<sub>2</sub> neutral electricity production. The one unit at the Magnum plant is expected to be fully fuelled by hydrogen in 2023.

However, for now the project will not be profitable on its own merits and NUON and its partners will apply for €200 million a year in subsidies from national and European sources.



**Figure 12:** NUON's Magnum hydrogen power plant

## **HYDROGEN FOR HEATING - H21 LEEDS CITY GATE (OPERATIONAL BY 2032)**

The H21 Leeds City Gate project aims to determine the feasibility, from both a technical and economic point of view, of transforming the existing natural gas network in Leeds<sup>25</sup> into a 100% hydrogen gas network. Leeds is one of the UK's major cities, and the area to be supplied with hydrogen in this project includes both the city and some of its suburbs. Thus, the scale of the project is significant and it covers households, industry, public organisations and commercial users and will reach approximately 660,000 people.

Since 2002, the UK has been upgrading the majority of its gas pipelines to polyethylene, which is suitable for transporting hydrogen.<sup>26</sup> This process is expected to be completed in 2032. For Leeds, it will

25 Ownership of UK's gas network: The National Grid owns National Transmission System and the Gas Distribution Network owns the Local Transmission System.

26 Before the discovery of natural gas in the North Sea the UK's locally produced town gas contained 50% hydrogen for over 150 years. In the 1960s the UK converted its town gas system to support natural gas.



be possible to upgrade the city's complete natural gas network to hydrogen within the next three years once the project starts. This process will mainly take place during the summer months when the demand for heating is low. The full network is expected to be operational by 2025.

For this project, hydrogen will be provided by SMR technology in four reformers that have a total capacity of 1,025 MW located at Teesside. As this conventional way of producing hydrogen emits significant amounts of CO<sub>2</sub> there it is planned to capture and store the CO<sub>2</sub> under the North Sea - 90% of the emissions or 1.5 million tonnes of CO<sub>2</sub> per year would be captured this way. Thus, transforming the Leeds natural gas network to hydrogen would reduce CO<sub>2</sub> emissions from heat, transport and power generation by 73%.

For intra-day and inter-seasonal storage of hydrogen, salt caverns on the East Humber coast will be used. A Hydrogen Transmission Pressure (HTS) pipeline will connect the steam methane reformers and salt caverns to the areas in the city, and will be able to transport at least the peak supply requirement.

The total project costs are estimated at £2 billion, split between 50% for appliance upgrades across the city and 50% for building the hydrogen production, storage and pipeline infrastructure. Additionally, £140 million annual costs are required for hydrogen production and CCS. However, annual costs are expected to decrease significantly over time due to economies of scale, and the project aims to provide households with heating at the same price as that of natural gas.

The Leeds City Gate project would be a good example for hydrogen conversion in other cities. In the UK, rolling out the Leeds City Gate project to the rest of the country would help achieving its carbon emission reduction target.

**Figure 13:**  
H21 Leeds City Gate

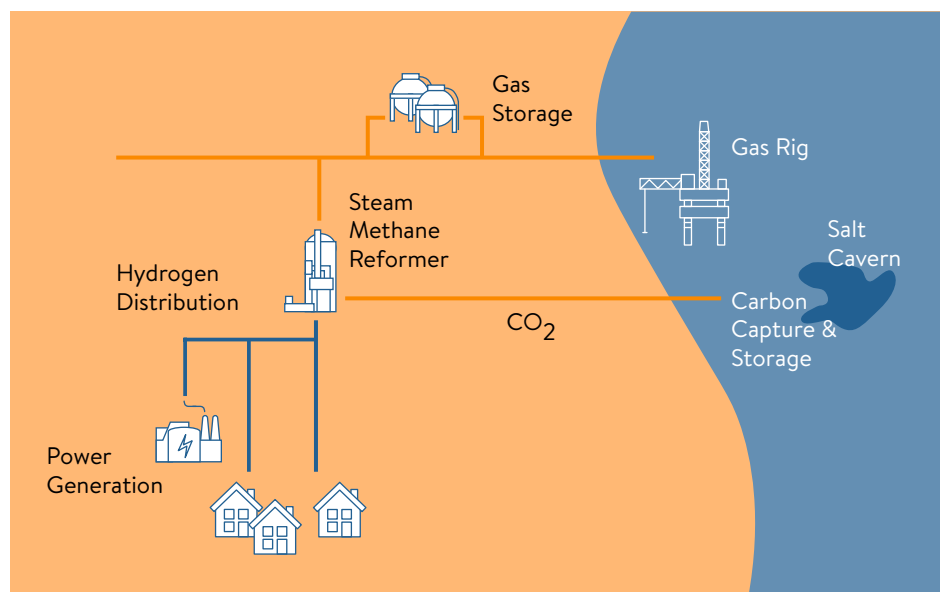

## THE NORTH SEA WIND POWER HUB (OPERATIONAL BY 2035)

As explained earlier, currently most wind farms are located near shore, but in the future the construction of wind farms is expected to move further and further from the shore. This poses a dilemma as costs of construction, maintenance and power transport are considerably higher the further away you move from the shore.

As a possible solution, TenneT, the Dutch TSO, has developed a concept for creating a North Sea Wind Power Hub on an artificial island, in order to facilitate construction and maintenance of wind farms, but also to enable international power trade. The project has now been taken on board as a joint collaboration between TenneT (Netherlands and Germany), Energinet, Gasunie and the Port of Rotterdam and is expected to be operational by the early 2030s.

According to the plan, 30 GW of offshore wind capacity would be constructed in the vicinity of the island, and the wind farms would be connected to the island via AC cables, where the AC to DC conversion could take place in order to connect the island to shore via HVDC cables. This would avoid both the need for individual DC cables from each wind farm, as well as the need for converter stations on platforms, and would lead to substantial efficiency gains and thus cost savings. In effect the artificial island would become a main interconnector for offshore wind power, linking the electricity markets of the UK, the Netherlands, Germany, Denmark and Norway. In addition to acting as a power interconnector, surplus wind power would be converted to hydrogen on the island.



**Figure 14:** Impression of the North Sea Wind Power Hub



**Figure 15:** Map of the North Sea Wind Power Hub

The planned location for the power hub is the Dogger Bank at the intersection of the Norwegian trench and the north and south North Sea and was selected for its wind profile (strong winds) and shallow waters, which ensure relatively lower construction prices. Up to three islands, each with 30 GW offshore wind capacity connected to it. Each island, including the one now being planned, would have a size of 6 km<sup>2</sup>.<sup>27</sup>

<sup>27</sup> TenneT (2017), retrieved from <https://www.tennet.eu/nl/onze-kerntaken/innovaties/north-sea-infrastructure/>

The Dogger Bank is a Natura 2000 area, and thus a protected area with regard to flora and fauna. A first assessment of the impact on flora and fauna on the Dogger Bank shows opportunities as well as potential risks for biodiversity and animals. Overall, environmental groups remain positive as the island would have a large positive impact on the reduction of CO<sub>2</sub> emissions.

Although, the North Sea Wind Power hub project is still in the development phase it already is a good example of international collaboration in the energy transition.

6

# THE ECONOMICS OF NORTH SEA ENERGY PATHWAYS



In this report we conclude that there are various ways to deliver the wind power produced on the North Sea to the end consumers. This chapter aims to derive high level conclusions on the economic viability of the various options. In order to arrive at those conclusions, we first identify the various pathways to the end consumer and their cost characteristics. The characteristics of the pathways are input to a costs and revenue model which is used to assess the economic viability of the pathways. Finally, the analysis of economic viability informs a scenario which presents a possible future for North Sea renewable energy production.

North Sea wind energy can be brought to the end consumer in several ways. We identify three high level stylised pathways:

- 1) Electricity-only, in which energy produced is transported as electrons over electricity cables and then consumed as electricity on shore;
- 2) Onshore electrolysis, in which power produced offshore is transported to the onshore electricity grid via electricity cables (as above) but then converted to hydrogen onshore and consumed as hydrogen; and
- 3) Offshore electrolysis, in which the power produced offshore is converted to hydrogen through offshore electrolysis and subsequently transported through to the shore through pipelines where it is consumed as hydrogen.

Several sub-pathways or variations can of course be identified.

### EXPLORING THE ECONOMIC VIABILITY OF THE DIFFERENT PATHWAYS

Figure 16 presents the stylised pathways and their variations, which have been used for the purpose of our economic modelling. In what is essentially a costs and revenue model, each distinct pathway is characterised by various nodes with associated costs, including energy losses. For example, for the electricity-only pathway the model includes the costs of electricity cables and converters, with near shore wind parks using HVAC and parks further away using HVDC connections. The electrolysis pathways include nodes such as electrolysis, compression in order to transport the hydrogen, and the costs of pipelines. There is also a timing dilemma in that much of the development costs are up front, while revenues and costs of operation of these typically long running project occur at a much later stage. The way we dealt with this dilemma is that the development costs of the infrastructure is included at full (fixed and variable) costs.<sup>28</sup>

---

<sup>28</sup> The model does not take into account the costs of the turbines and inter-array cables, as these costs are the same for all pathways explored.

**Figure 16:** schematic overview of the pathways included the analysis

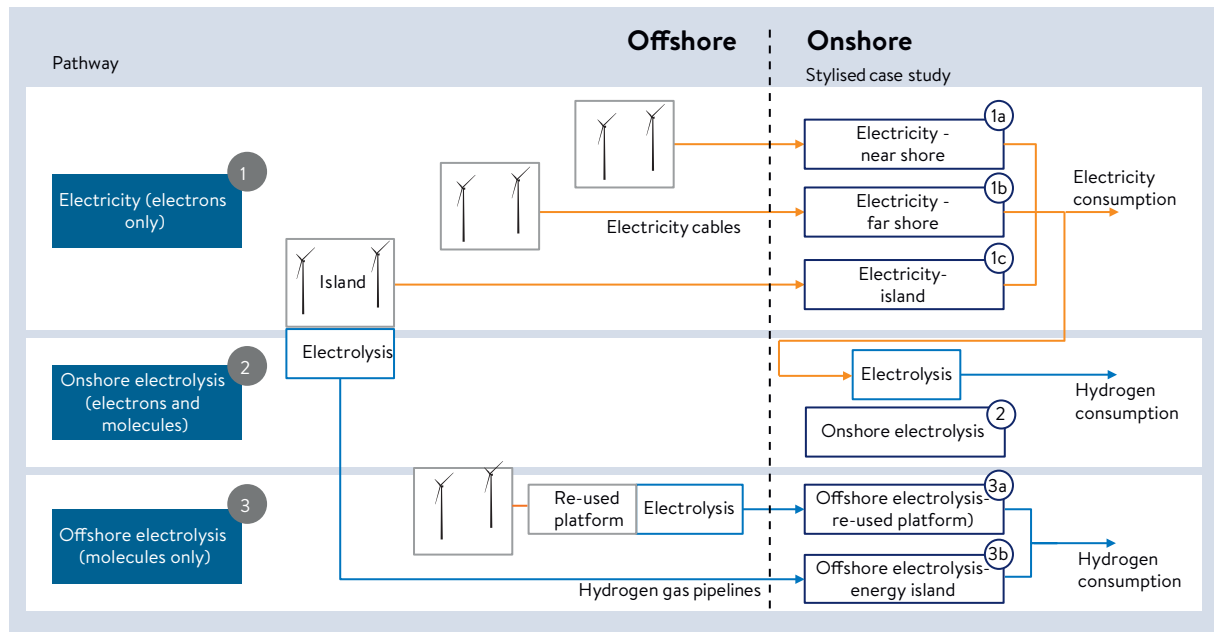

Figure 17 presents the estimated costs per MWh for each pathway in 2018 and in 2030.<sup>29</sup> It is clear that the electricity-only options are cheaper options than those including electrolysis. This is true in particular today in 2018. However, onshore and offshore electrolysis may well become more competitive in 2030, which would largely be driven by the fact that substantial technology cost reductions are assumed to reflect the relatively immature character of the technology at current low volumes. Fast cost reductions thanks to a steep learning curve and increasing economies of scale are not uncommon in renewable energy development.<sup>30</sup>

Recently the new plan for North Sea Power Hub on an artificial island has arisen, and is widely attracting keen interest. Therefore the viability of such an artificial power hub is explored too. Energy island options are thought to be relatively competitive, as result of possibilities for coordinated roll-out of infrastructure and economies of scale due to high volume, long term commitments.<sup>31</sup> In the modelling, part of the efficiency gains (lower transport costs per MWh) are negated by the assumption that more countries would be connected. Connecting more countries does increase the revenue options, but at the same time multiplies the costs of electricity cables.

29 Sources used include: Entso-e (2012), ABB (2017), Jepma (2017), JKU Linz (2017) and interviews with industry experts. Near shore wind farms are assumed to be located 40 kilometers from shore, far shore wind farms are assumed to be located 100 kilometers from shore.

30 See for example expected learning curves by Energieinstitut an der JKU Linz (2017). This is not dissimilar from learning curves for offshore wind production.

31 See for example TenneT (2017).

**Figure 17:** Estimated costs in € per MWh for all analysed pathways in 2018 and 2030

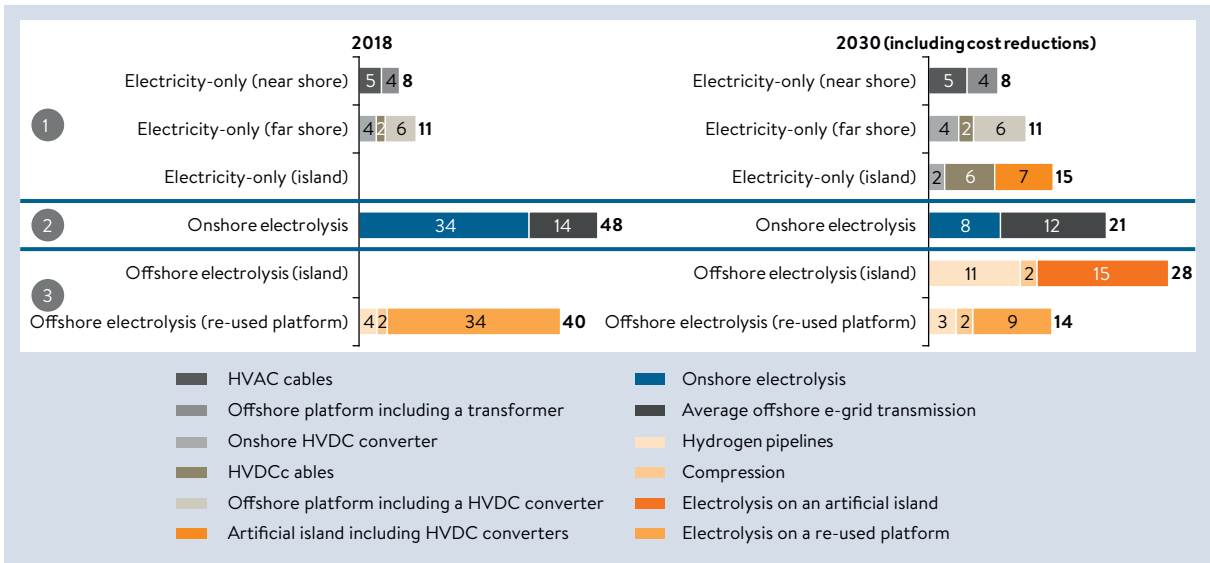

To assess the potential future economic viability, the costs are compared with the projected revenues for each pathway. Figure 18 presents the potential value for the pathways in 2030 against varying ('intermittent') electricity (left) and hydrogen (right) prices, all other things being equal. In the left figure, a fixed hydrogen price of €63 per MWh (€2,500 per tonne) is assumed, in the right figure a fixed price of €50 per MWh for electricity is assumed.<sup>32</sup> The figure illustrates that for electrolysis based pathways to become more viable than electricity-only, the electricity price would need to be either lower than ~€55-60 per MWh or the hydrogen price would need to be higher than ~€2200-2600 per tonne (given above mentioned costs and price assumptions).

**Figure 18:** Relation pathways' potential value and electricity (left) and hydrogen (right) price in 2030

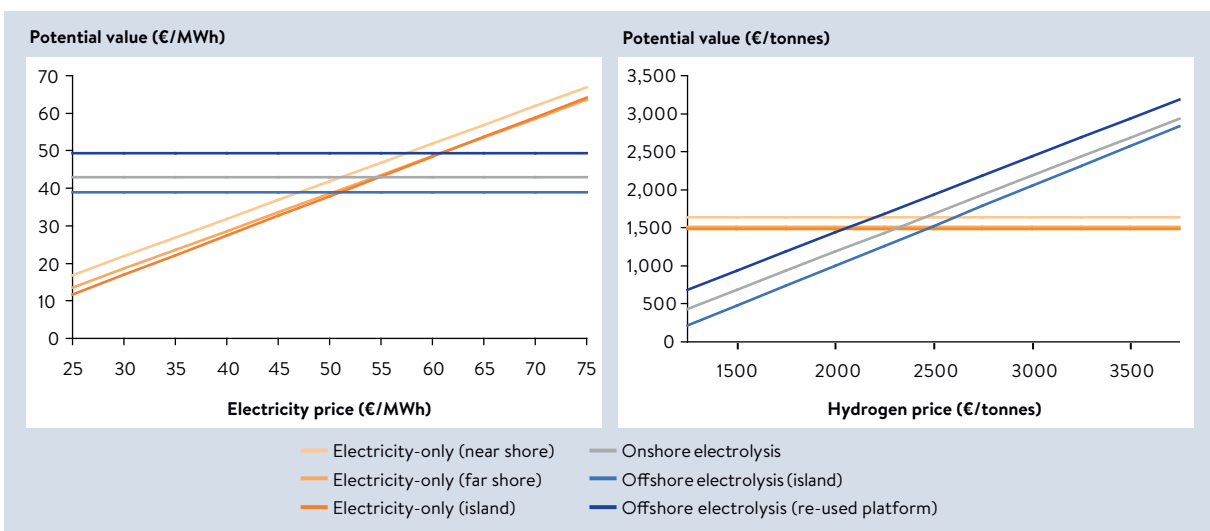

<sup>32</sup> Price assumptions are based on the Nationale Energieverkenning 2017 by ECN, interviews with industry experts and analysis by PwC.

Figure 17 demonstrates that electrolysis options are relatively competitive as long as the hydrogen price is high enough compared to the electricity price. Given the potential applications of hydrogen, for example to drive decarbonisation in industry and transport, a price of around €2200 to 2600 per tonne does not seem unwarranted. The ultimate viability question from a purely economic point of view is thus to what extent the hydrogen market more broadly develops to such an extent that those price levels are reached. As several sources and current developments indicate this is not unimaginable.

Additionally, production of hydrogen through electrolysis could also be a relatively efficient way to store energy, which would justify a premium on top of the hydrogen price modelled. Offshore electrolysis is on average more expensive than onshore electrolysis. The utilisation of existing platforms might be the exception, especially if old gas pipelines may be retrofitted to transport hydrogen which would lead to additional savings on the transportation costs. The financial benefit that decommissioning costs of the platforms could be delayed for this purpose have not been modelled and thus provides an upside to the offshore electrolysis pathway. On the other hand, there is only a relatively limited number of platforms that may be re-used and an even smaller part are large enough to facilitate the conversion of a substantial part of the capacity of a wind farm.

Onshore electrolysis appears to be a competitive option as well. It could save transportation costs compared to building dedicated offshore hydrogen transportation infrastructure. A very important question is where onshore electrolysis should be located. Demand and supply would have to be sufficiently close in order to avoid substantial additional costs of onshore transportation. This exactly demonstrates why ports are considered a relatively attractive place for energy supply and the consumer (i.e. industry) to meet.

The values of the electricity-only pathways assume that all electricity can be consumed free of costs once it is connected to shore. In reality, substantial onshore grid adjustment costs are likely to be needed if more and more electricity is produced on the North Sea and brought to shore to be fed into the electricity grid. The costs for expanding the capacity of the electricity grid to accommodate the increased demand for power could run into billions, according to estimates.<sup>33</sup>

Furthermore, the electricity-only numbers reflect the importance of location and distance to shore: the further away from the shore, the more expensive. If more and more attractive locations are used, the rationale for a North Sea power hub increases. Instead of laying cables from each individual wind farm to the shore, cabling could be combined and the wind farms near the island could be connected to the island using AC infrastructure. Other benefits include costs savings due to a coordinated configuration and the option to choose the direction of the energy flow towards the regions of scarcity (and high prices) in as island would be connected to multiple countries.<sup>34</sup>

---

33 Entso-e (2015), Close to zero emission by 2050 means from €100 to €400 billion investment in electricity transmission: <https://www.entsoe.eu/news-events/announcements/announcements-archive/Pages/News/e-Highway2050-concludes.aspx>

34 For the paths that comprise an island a premium of 5% is included in the revenue to account for the possibility to sell to the highest bidder in any of the connected countries.



While plans for energy islands are typically being developed with the aim to host wind farms in the surrounding sea and conversion infrastructure on the actual island itself, there is an option to reserve space for offshore electrolysis on the island. Whether it is sensible to sacrifice space for electrolysis on an island would be an interesting question for further research.

## THE POTENTIAL FOR A HYBRID NORTH SEA POWER AND HYDROGEN FUTURE

The analysis of the economic viability of various pathways demonstrates that hydrogen, or molecules, based energy transportation and consumption is a promising way to bring North Sea energy to the consumer, alongside direct usage of the variable power. Given the potential for further cost reductions and the potential future commercial value of hydrogen as a multi-purpose energy carrier, developing hydrogen capacity could be a viable investment.

Based on the analysis above, a possible high level scenario can be constructed for North Sea hydrogen in the future. Table 4 offers an indicative calculation of what the hydrogen pathways could look like in 2030 and beyond. As a starting point, around 8 GW of the installed North Sea wind capacity could be used to produce hydrogen. Given the fact the current installed hydrogen capacity is close to zero, this would be a strong ramp up which can be compared with the acceleration of offshore wind over the past decade. Following the growth of the installed offshore wind capacity, in 2050 the hydrogen production park might grow to an installed capacity of 40 GW.

**Table 4:** A potential future for hydrogen in 2030

	2030		2050	
	Offshore electrolysis	Onshore electrolysis	Offshore electrolysis	Onshore electrolysis
GW	2	8	10	50
GWh	8,400	33,500	72,700	363,300
% North Sea Area total industry energy demand	0.5%	2%	3.1%	15.6%
Estimate of required investment in billions	€0.8-1.1 bln	€5.1-6.8 bln	€5.6-7.6 bln	€20.1-27.2 bln
CO <sub>2</sub> reduction	1.4 megaton	5.7 megaton	13.8 megaton	69.2 megaton

According to our modelling, the hydrogen future in 2030 would require capex investments in the order of €5-7.5 billion up to 2030 and in the order of €27-37 billion up to 2050. The majority of this investment is in electrolysis capacity (costs of production, primarily the capex of developing farms, are excluded). The resulting amount of energy would be sufficient to cover around 12.5% of the energy demand in North Sea countries' industrial sectors in 2050. Compared to the current average CO<sub>2</sub> emissions, such a shift to green hydrogen would represent approximately 32 megaton in CO<sub>2</sub> savings annually when everything is built.

In addition, the hybrid power-hydrogen system on the North Sea enhances the security of supply of energy for the region around the North Sea, more than if an electricity-only system is developed.

Security of supply is the third aim of the energy trilemma, next to economic viability and CO<sub>2</sub> reduction. The additional option of an energy hub on an artificial island would also contribute to enhanced security of supply.

A fourth advantage of developing the hybrid system lies in the learning curve. Developing huge-scale integrated hybrid energy systems that connect different markets and regions, have the potential to increase the competitiveness of particular industries (such as chemicals, or hydrogen based transportation) and ignite ecosystems of high productivity. The coordinated development of the technologies and the market know-how can lead to exportable models, in exactly the way that is described in the Michael Porter argument about the competitiveness of nations.

## FROM DETAILED INFORMATION TO A STYLISED ECONOMIC MODEL

This report explores the various technological options of bringing wind energy produced on the North Sea to the shore and on to end user markets. The report describes the potential of currently available technologies, as well as the best available views on reasonably foreseeable options in the not too distant future, based on reasonable assumptions about technological developments. As such, the report takes a fairly modest stance when it comes to what will be possible in the future, as it just extrapolates current and emerging technology trends.

Technological pathway development is a matter of years and decades, and that holds for the pathways described in this report too. Which of the technologies will eventually be developed into maturity depends to a large extent on economics. More specifically, which will be the ‘winning’ technologies in the decades ahead depends on two parameters: (1) the costs of producing, converting, storing and transporting the energy carrier, and (2) the end user prices that can be achieved by applying the technology. Great technological advancements may lose in the market place to less elegant but eventually cheaper solutions, because the market will not embrace the expensive option.

The eventual success and feasibility of the different technologies in the market place thus depends not just on the performance of engineers, but also on the development of cost curves of technologies, and on the development of prices - each relative to their alternatives. Vice versa, economic market pull in response to costs and prices developments will drive economies of scale and scope, and drive economic efficiency of certain technologies. The spectacular cost reductions achieved in solar panel production or wind farm bids over the past decade, as a result of increasing demand, are telling examples.

In order to explore the economic viability windows we have designed a stylised economic model. The model is necessarily stylised, leaving out many details, firstly because it is quite impossible to model all the details of all the cases described, into one model, secondly because we are interested in broad ranges. Given the high degree of uncertainty over the life span, this is the best we can achieve.

The stylisation comes down to a number of key assumptions:

- A limited number of pathways - hydrogen, power, with conversion into one another to cope with intermittency
- Three economic parameters - costs of production, conversion, storage and transport, and end user prices of hydrogen and power
- Two time periods - 2018 to capture what is currently happening, and 2030 as the year when much of the expressed ambitions may have been implemented
- The speed of cost reduction - of production and conversion
- The scope from offshore production up to landing on shore - so excluding for instance required investments in additional infrastructure for hydrogen or power transportation on shore, which may be sizeable
- An offshore energy island - to be connected to different end user markets
- Costs and their allocation over time - approach of long-term averaged total costs to smooth the huge up-front investment costs across the life cycle of assets
- Quantification based on interviews and desk research - taking ranges where sources take different approaches or different views

The result is a model that provides insight into the cost and price ranges that are necessary to make hydrogen and power pathways economically viable.

As such, the economic model tries to answer the question of who spends and who earns with the development of the pathways. It does not answer the question of who needs to do what to achieve this, although potential beneficiaries will have incentives to drive the development, such as ports, hydrogen users, and energy consumers. The question of who needs to do what is addressed in the rest of the report

# 7

## THE CALL FOR ACTION: PUBLIC VERSUS PRIVATE SECTORS



From an economics perspective, problems arise when markets do not function properly – a phenomenon known as a ‘market failure’. There are several types of market failures. For example, problems can arise also if markets do not come into being due to high transaction costs and if welfare enhancing transactions cannot be made. Another example is externalities. These are effects of production and consumption that influence production opportunities and welfare of other parties but do not have a price. Without regulation, negative externalities result in overproduction.

Broadly speaking, a market failure is a situation in which the allocation of goods and services is not efficient, meaning that, there exists another conceivable outcome where at least one party may be made better-off without making another party worse-off. It describes any situation where the incentives for rational behaviour for the individual do not lead to rational outcomes for the group. In terms of activities on the North Sea, this can mean that each stakeholder makes a correct decision for him/ herself, but those prove to be sub-optimal decisions for the group.

Governments can intervene to correct and/ or contain the impact of market failures, and thus mapping potential market failures becomes an important tool in determining where governments (or the EU) should intervene and where, the required activities should instead be left up to the market parties involved. Using the matrix below, we therefore look at the potential market failures for the two pathways in this study, in order to formulate concrete recommendations for action, for governments/ the EU and the industry alike.

**Figure 19:** Market failures and government interventions

Market failures	
Public goods	Public goods are goods that are not delivered by the free market. They are defined as goods that are non-rivalry and non-exclusive.
External effects	External effects of the production of goods or services, negatively or positively, affect third parties who are not involved in the production decision.
Information assymetry	The different parties involved do not have the same access to information. This can result in coordination problems and unfair advantages.
Transaction costs	The cost of executing a transaction. If transaction costs are high, they can hinder the functioning of markets.
Market power	Market power exists if one party can profitably raise its prices above its marginal cost. This can arise from the three forms of market failure: barriers to market entry, economies of scale or scope, and network effects. These market failures limit competition and increase market concentration and hence market power.
Government failure	

Government interventions can lead to undesirable distortions in the functioning of markets. Before a government intervenes in a market, it should carefully evaluate if the cost of the market failure is larger than the cost of the intervention. Only if the cost of the market failure outweighs the effects of government intervention should it choose to act.

## MARKET FAILURES AND ECONOMIC ACTIVITY ON THE NORTH SEA

Governments have a vital role to play in the transformation towards a sustainable energy system as it seeks to protect its citizens from negative externalities – air pollution and climate change. Without government intervention excess CO<sub>2</sub> would be emitted. This is because the cost of the negative externalities – pollution – is not borne (fully) by the emitter and hence, the presence of a negative externality will not affect his/ her decision to emit or not.

Moreover, clean air has characteristics of a public good since it is impossible to exclude anyone from breathing or using clean air, up until a certain threshold, the use by one consumer is not at the expense of another. Thus, it is impossible to exclude people from the use of the good and the marginal costs of an extra user are zero, and consumers will be unwilling to pay for these goods on an individual basis.

Given the presence of a negative externality and the fact that clean air is a public good, governments may choose to intervene to correct these market failures. Examples of how governments may choose to intervene to limit pollution are the EU's Emission Trading Scheme, pigouvian taxes or renewable energy subsidy schemes. However, in order to correct for this negative externality, pigouvian taxes are – from an economic point of view – preferred over subsidies.

A third market failure which could justify government intervention is information asymmetry whereby one or a few market parties have access to non-public information which gives them a competitive advantage over other market players. This would hamper both fair competition and potentially effective coordination between stakeholders, and is mainly due to the fact that the group of stakeholders is large and diverse. Short-term strategic behaviour among stakeholders may prevent actors from pursuing synergy effects and thus limit the overall joint value creation. Governments could facilitate cooperation between stakeholders to solve information asymmetry problems to the benefit of all stakeholders.

For offshore renewable energy, and in particular offshore wind, the recently signed Political Declaration on energy cooperation between the North Sea countries (Belgium, Denmark, France, Germany, Ireland, Luxembourg, the Netherlands, Norway, the UK and Sweden) provides a framework for cooperation across borders. It helps to limit information asymmetries and facilitates a joint discussion on the consequences of externalities. The next step would be to convert this political commitment into practical actions that drive change. This is particularly important for the development of international offshore electricity grids and hydrogen gas pipeline infrastructure.

## SOME POTENTIAL HURDLES TO THE OPTIMAL FUNCTIONING OF A GREEN HYDROGEN MARKET

**Figure 20:** Market failures and government interventions in the molecules pathway

Market failures	
Public goods	Clean air and R&D are examples of public goods
External effects	CO <sub>2</sub> emissions are an example of negative externalities
Information asymmetry	Transparent spatial planning with regard to the offshore and onshore hydrogen network reduces information asymmetry.
Transaction costs	Efficient planning of the hydrogen grid and government subsidies reduce high transaction costs.
Market power	Opening the hydrogen market to other parties reduces market power of a single party.
Government failure	

The large scale deployment of offshore wind is carried out with a time horizon of more than a decade. As such it is essential that operators can rely on the government not to change the regulatory regime too frequently in relation to the hydrogen pathway.

Negative externalities, information asymmetry, transaction costs, and market power are all potential hurdles to the optimal implementation of the hydrogen pathway, and governments have a role to play if the cost of government intervention does not exceed the correction of the market failure.

Green hydrogen from wind power is a technology which is still under development and R&D to develop the technology is crucial. This research is considered to be a **public good** and is supported by government subsidies. In the context of this report the question is whether the level of support is sufficient to kick-start the roll-out of this technology across sectors. To overcome this hurdle governments could increase their support for research into power-to-gas technology.

Green hydrogen is not price competitive when compared to fossil fuel based alternatives. Fossil fuel prices are currently relatively cheap and CO<sub>2</sub> emission allowances are not incentivising producers to produce green hydrogen at a large scale. Nevertheless, developing a green hydrogen market based on wind power is socially desirable. Thus government intervention would be justified as it internalises the negative **externalities** of CO<sub>2</sub> emissions.

To correct this market failure, governments (or the EU) may intervene to set lower CO<sub>2</sub> emission allowances in order to stimulate the production of green hydrogen as a non-polluting alternative to fossil fuels. In addition, governments could secure competitive energy prices by scaling up offshore wind which is already cost competitive. Lower electricity prices from renewable sources, together with lower CO<sub>2</sub> emission allowances, would help make green hydrogen cost competitive as a feedstock.

Information on where offshore gas pipelines are located is not publicly available since the offshore infrastructure is owned by private parties. This lends the development of the offshore hydrogen market to potential **information asymmetries**, where some market parties may have access to information that gives

35 Subsidies have been suggested as another potential remedy to high transaction costs, but they are by definition more distortive than coordination.

them an unfair advantage vis-a-vis other market players. To correct this market failure, governments may intervene to provide adequate spatial planning and by creating a platform for sharing information.

Developing production facilities and building the infrastructure for offshore and onshore production and transportation of hydrogen are large-scale capital intensive projects where high **transaction costs** may act as a barrier to market entry. Governments can play a vital role in the success of projects by coordinating stakeholders to share costs, thus overcoming transaction costs as a barrier to market entry.<sup>35</sup>

In the development of the offshore hydrogen network, owners of offshore gas pipelines will have increased **market power** and monopolies can arise. The government should play a key role in setting the regulation to allow fair competition, for example by opening up the gas network for third parties. However, in the very early stage of developing the offshore hydrogen market, there may be cases where the government need to exempt third party access in order to get private investors interested in new projects (such as was the case in the BBL gas pipeline project between the Netherlands and the UK, see page 27).

## SOME POTENTIAL HURDLES TO THE OPTIMAL FUNCTIONING OF THE OFFSHORE ELECTRICITY MARKET

**Figure 21:** Market failures and government interventions in the electrons pathway

Market failures	
Public goods	Clean air and R&D are examples of public goods
External effects	CO <sub>2</sub> emissions are an example of negative externalities
Information asymmetry	Transparent spatial planning with regard to the offshore and onshore electricity grid reduces information asymmetry.
Transaction costs	Efficient spatial planning of the meshed electricity grid and government subsidies reduce high transaction costs.
Market power	Opening the offshore electricity market to other parties reduces market power of a single party.
Government failure	

The large scale deployment of offshore wind is carried out with a time horizon of more than a decade. As such it is essential that operators can rely on the government not to change the regulatory regime too frequently in relation to the electrons pathway.

The electrons pathway is currently the status quo, but to meet the full wind power capacity of the North Sea, the offshore electricity grid will need to expand to a large extent. Externalities, information asymmetry, transaction costs, and market power are all potential hurdles to the optimal implementation of the electrons pathway, and governments have a role to play.

Green electricity is not yet at par with fossil fuel based alternatives in terms of price competitiveness due to, among other, high transportation costs from sea to shore. Furthermore, conventional electricity



prices are currently relatively cheap and CO<sub>2</sub> emission allowances are not incentivising producers to produce green electricity at a large scale. Nonetheless, developing a green electricity market based on wind power is considered socially desirable – it reduces CO<sub>2</sub> emissions, which is a negative **externality** - and thus government intervention would be justified.

To correct this market failure, governments (or the EU) may intervene to set lower CO<sub>2</sub> emission allowances to stimulate the production of green electricity. In addition, governments could secure competitive energy prices by scaling up offshore wind which is already cost competitive. Lower electricity prices from renewable sources, together with lower CO<sub>2</sub> emission allowances, would help make green electricity cost competitive compared to electricity generated from coal and natural gas.

The difficulty of gathering information about the conditions at sea also lends the offshore electricity market to potential **information asymmetries**, where some market parties may have access to information that gives them an unfair advantage vis-a-vis other market players. To correct this market failure, governments may intervene to limit information asymmetry by facilitating cross border information sharing and adequate spatial planning.

Towards 2030 the meshed offshore electricity grid will be developed and additional interconnectors will need to be constructed in order to meet the North Sea's wind power capacity of 60GW. By the early 2030s, international energy hubs such as the North Sea Wind Power Hub at the Dogger Bank will be built – contributing to a total of 180 GW of wind power capacity by 2050. These projects are large-scale capital intensive and therefore require substantial investments. Initial **transaction costs** are therefore high and can constitute a barrier to market entry. Governments can play a vital role in the success of projects by coordinating stakeholders to share costs, thus overcoming transaction costs as a barrier to market entry.<sup>36</sup>

One example of how the Dutch government has played a role in reducing both information asymmetry and high transaction costs has been by appointing its TSO TenneT (100% state owned) to also become the offshore TSO with responsibility for grid connections for offshore wind farms. By carrying out these activities, the government helped avoid information asymmetries, and substantially lowered the financial risks, as well as transaction and tendering costs for the interested parties.

Lastly, in the development of large scale offshore wind projects, organisations involved in initial projects may gain information that are not available to other market players. As those players are often a few large industry players they also gain scale advantages which may enable them to win further tenders and divide the market between themselves going forward. This 'concentration' effect results in substantial **market power**, preventing other players from entering the market. The government should play a key role in preventing this type of market abuse by making sure there is a level playing field for all players.

---

<sup>36</sup> Subsidies have been suggested as another potential remedy to high transaction costs, but they are by definition more distortive than coordination.

# 8

## CONCLUSIONS & RECOMMENDATION



## **IMPORTANT NEXT STEPS FOR SUCCESSFUL NORTH SEA COOPERATION**

International cooperation between the North Sea countries is vital for the region to achieve its targets under the Paris Climate Agreement. The cross border nature of climate change, and the energy transition needed to mitigate it, means that countries need to cooperate in order to solve the problem. In addition, synergy effects can be exploited if countries cooperate in the development of renewable energies available on the North Sea. Regional cooperation would facilitate optimal energy transmission and encourage further European energy market integration, while achieving efficiency gains.

While green electricity is the status quo, and will be scaled up to a large extent, hydrogen through power-to-gas technology would be an important way to improve security of supply, while reducing CO<sub>2</sub> emissions in sectors which would otherwise be difficult to decarbonise. If produced at a large enough scale, green hydrogen could furthermore become an affordable alternative to fossil fuels, thus adding to the affordability criteria of the energy trilemma: sustainability, affordability and security of supply.

As highlighted in the introduction, the large existing gas infrastructure could provide North West Europe with a competitive advantage that countries could capitalise on to be first movers, and incentivise stakeholders to lead technology development when it comes to hydrogen.

### **THE ROLE OF EU**

- The EU should work on improving the EU ETS to drive higher CO<sub>2</sub> emission prices to stimulate the production of green electricity, as well as green hydrogen as a way to decarbonise industry.
- The EU should play a facilitating role in driving cooperation between the North Sea countries, in order to ensure that countries do not act in isolation, looking only at the national level.
- The EU also has role to play in harmonising regulation in the EU member states as outlined in chapter 4, and in particular in relation to hydrogen as a zero emissions fuel.

### **THE ROLE OF NATIONAL GOVERNMENTS**

- Governments should ensure a shared vision for the energy transformation on the North Sea and invest in research and pilot programmes.
- Governments should contribute to lowering the cost of green energy, including that of green hydrogen by scaling up the rollout of renewable energy sources, including offshore wind.
- Governments should make sure that information is publicly available, for example through an information sharing platform with information on spatial planning, regulation and other aspects that could affect investment decisions of companies.
- Governments should consider providing support for large capital intensive projects in order to overcome high initial transaction costs. The North Sea Wind Power Hub is one example of the type of project that would benefit from government support.



- Governments also play a key role in providing adequate, but not excessive, regulation. It would be important to coordinate this regulation between North Sea countries.
  - Adequate regulation would include third party access rules for offshore power and gas (hydrogen) infrastructure, in order to avoid the abuse of market power by one party.
  - Allowing existing natural gas infrastructure to be used for the transportation of hydrogen is another very important example of a regulatory change that would enable the commercial uptake of power-to-gas technology.

### **THE ROLE OF (PRIVATE) MARKET PLAYERS**

- Market players should share knowledge of green energy business cases where international cooperation has been successful and financial benefits have been shared between companies.
- Industry, and particularly the chemicals industry, should explore opportunities for business cases that would help develop a green hydrogen market.
- Ports will play a vital role as landing points for offshore energy from the North Sea and should explore ways of providing storage for green hydrogen, as well as conversion and transportation facilities.
- Companies should explore opportunities for EU funding for offshore energy projects for example through the EU's Interreg North Sea Region Programme, the European Fund for Strategic Investments (EFSI) or the Connecting Europe Facility (CEF).
- Industry organisations, such as the WEC, should facilitate dialogue between market players across borders through series of meetings, including high level conferences.

